

COMPATIBLE PATIENT MONITOR ACCESSORIES CATALOG

SpO2, ECG, EKG, NIBP, IBP, Temperature, Ultrasound and O2

- **Low-price guarantee:** We'll beat any competitive price – guaranteed.
- **Buy from experts:** We know patient monitor accessories like no one else.

809-531-2628 • www.cablesmedical.com



**Cables Medical
& Sensors PYF**

To our customers:

Thank you for choosing us as one of your trusted suppliers. We know that with every product we ship we are under the obligation to exceed your expectations in price, quality and service. For this reason we make these five promises to you today:

- We guarantee that you will be working with experts: patient monitor accessories is our only business, we know it like no one else.
- We guarantee that you will always get the best price when buying from us. If you find any comparable product priced lower than ours, we'll not only match it but also beat the quoted price. Guaranteed.
- We guarantee that all orders received before 5PM EST for any of our thousands of in-stock products will ship fast.
- We guarantee that you will love the quality of our products or we will refund your money - no questions asked and with no restocking fees.
- We guarantee that working with us will be easy, unique and refreshing. We're passionate and proud to be different.

Please use this catalog to explore our full family of compatible patient monitor accessories. You can also find all our products along with full-color photographs of each and a powerful cross-reference search engine on our oh-so-easy to use website at: www.cablesmedical.com

We look forward to working with you.

Zona Industrial de Herrrea
809-531-2628 • www.cablesmedical.com



Table of Contents

SpO2 Probes & Adapters	7
ECG Cables & Leadwires (3 or 5 leads)	51
EKG Patient Cables & Leadwires (10 leads)	75
NIBP Hoses, Cuffs & Connectors	86
IBP Adapters, Converters & Disposable Transducers	98
Temperature Probes	109
Ultrasound Transducers & Repair Cables	116
O₂ Cells for Respiratory Applications	120
Warranty Information	131

809-531-2628 • www.cablesmedical.com



Direct Connect Sensors
9 foot cable

Short Sensors
3 foot cable

Disposable Sensors
3 foot cable

Adapter Cables
1, 4, 7, 8, 10 or 12 feet

SpO2

Compatible SpO2 probes, adapters and accessories

SpO2 Accessories

Choosing your SpO2 probe



Adult Clip

Best for a secure grab and for short-term, spot-checking.
Patient size: >85lbs



Adult Soft

Best for patient comfort and long-term care.
Patient size >85lbs



Pediatric Clip

Stronger hold for the little ones that like to move.
Patient size: 30 – 85lbs



Pediatric Soft

A more gentle grab for longer-term monitoring.
Patient size: 30 – 85lbs



Infant Soft

A gentle option for the smaller ones. Patient size: 6 – 30lbs.
Select models only.

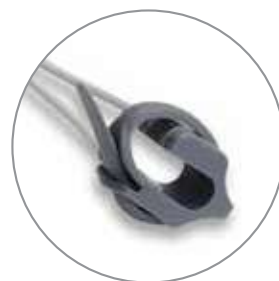

Neonate Wrap

Gentle foot wrap for newborns.
Patient size: 2 – 7lbs



Multi-Site

A versatile option for all patient sizes. Apply on foot, finger or ear lobe (with attachment).



Adult Ear Clip

Best choice for patients with low perfusion or burns.
Select models only.



Adult Finger Wrap

An alternative option for adult finger application.
Select models only.

BCI Direct Connect Sensors

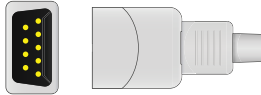
Models	Connector	Options	Part Number	OEM #
3180, 3300, 3404, 3444, 6100, 9100, Advisor, Autocorr, Mini Torr, Mini Torr Plus; Larsen & Toubro Limited (L&T Medical) Stellar P, Star 50, Galaxy, Planet, Planet 50, Cosmic		Adult Clip	S410-760	
		Adult Soft	S410S-760	
		Pediatric Clip	S103-760	
		Pediatric Soft	S103S-760	
		Neonate Wrap	S310-760	
		Multi-Site	S810-760	
3300, 3301, 3302, 3303, 3304, 3400, 3401, 3403, 9200; Spacelabs Burdick: PRO2; Drager: Oxipac 2000; MMedChoice: MD300A; Invacare 3300nv		Adult Clip	S410-060	
		Adult Soft	S410S-060	
		Pediatric Clip	S110-060	
		Pediatric Soft	S110S-060	
		Neonate Wrap	S310-060	
		Multi-Site	S810-060	



BCI Short Sensors

Models	Connector	Options	Part Number	OEM #
3180, 3401, 3304, 3303, 3302, 3301, 3300, 3400, 3403, Smiths Medical BCI Capnocheck 9004, Spectro 2 10, 20, 30, SurgiVet; Spacelabs Burdick: PRO2; Drager: Drager Oxipac 2000; Armstrong Medical AD-1000; Beijing Choice Electronic: Pulse Oximeter model MD30011		Adult Clip	S403-060	3444
		Adult Soft	S403S-060	
		Pediatric Clip	S103-060	3178
		Pediatric Soft	S103S-060	
		Neonate Wrap	S303-060	
		Multi-Site	S8030-060	

BCI Disposable Sensors

Models	Connector	Options	Part Number	OEM #
		Adult Box of 24	S503-060	1300
		Pediatric Box of 24	S523-060	1301
		Infant Box of 24	S533-060	1303
		Neonate Box of 24	S543-060	1302

BCI Adapter Cables

Models	Connector	Options	Part Number	OEM #
6100, 9100, Advisor, Autocorr, Mini Torr and Mini Torr Plus	<p>To Monitor:</p>  <p>To BCI Sensor:</p> 	7 Foot Adapter	E708-760	

Biolight Direct Connect Sensors

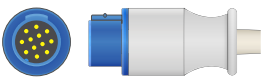
Models	Connector	Options	Part Number	OEM #
M7000		Adult Clip	S410-68D0	
		Adult Soft	S410S-68D0	
		Pediatric Clip	S110-68D0	
		Pediatric Soft	S110S-68D0	
		Neonate Wrap	S310-68D0	
		Multi-Site	S810-68D0	

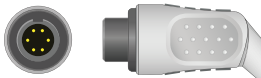

Bionet Direct Connect Sensors

Models	Connector	Options	Part Number	OEM #
BM3		Adult Clip	S410-580	
		Adult Soft	S410S-580	
		Pediatric Clip	S110-580	
		Pediatric Soft	S110S-580	
		Neonate Wrap	S310-580	
		Multi-Site	S810-580	
BM3		Adult Clip	S410-1080	
		Adult Soft	S410S-1080	
		Pediatric Clip	S110-1080	
		Pediatric Soft	S110S-1080	
		Neonate Wrap	S310-1080	
		Multi-Site	S810-1080	

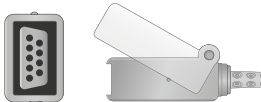
Bionet Adapter Cables

Models	Connector	Options	Part Number	OEM #
BM3, BM3 Plus	<p>To Monitor:</p>  <p>To Nellcor non-Oximax Sensor:</p> 	7 Foot Adapter	E708-580	

Cardell Adapter Cables

Models	Connector	Options	Part Number	OEM #
Cardell MAX-12 Duo HD and 9500 Series	<p>To Monitor:</p>  <p>To Nellcor Oximax Sensor:</p> 	10 Foot Adapter	E710P-380	

CAS Med *(See Nellcor)*

Corometrics Adapter Cables

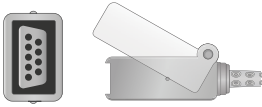
Models	Connector	Options	Part Number	OEM #
Corometrics 118, 511 and 556	<p>To Monitor:</p>  <p>To Nellcor non-Oximax Sensor:</p> 	7 Foot Adapter	E708-250	4033CAX

Criticare Direct Connect Sensors

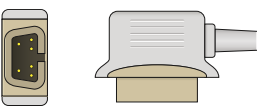
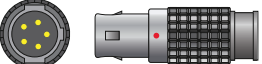
Models	Connector	Options	Part Number	OEM #
Alaris 4415 (IVAC): VitalCheck 4400, 4410; Criticare: 503DX-W, 503S, 503DX, 503 Spot, 504DX/P, 504DX, 506 series (except 506LN3), 507ELC2, 8000 series, 8100 series, Poet Plus, Poet R Plus, Poet (602-3A), Scholar, Scholar III, nGenuity		Adult Clip	S410-750	934-10DN
		Adult Soft	S410S-750	975AD-10
		Pediatric Clip	S110-750	1563-10D
		Pediatric Soft	S110S-750	975PD-10
		Neonate Wrap	S310-750	
		Multi-Site	S810-750	
Scholar, Poet (602-3A), 1100, 2200, 500, 500A 501, 502 series, 503, 504, 504/P, 5040/P, 504US/P, 507, 507E/P/R, 507/S, 507SD, 5070/P, 508, 509, 581		Adult Clip	S410-050	934-10LN
		Adult Soft	S410S-050	975AD-10L
		Pediatric Clip	S110-050	1563-10L
		Pediatric Soft	S110S-050	975PD-10L
		Neonate Wrap	S310-050	
		Multi-Site	S810-050	940-10L



Criticare Short Sensors

Models	Connector	Options	Part Number	OEM #
Alaris (IVAC): VitalCheck 4400 511SD; Criticare: 503DX-W, 503S, 503DX, 503 Spot, Mini Spot, 504DX/P, 504DX, 506 series (except 506LN3), 507ELC2, 507EL, 8100 series, Poet Plus, Poet (602-3A), Scholar, Scholar III		Adult clip	S403-750	934SDN
		Adult soft	S403S-750	975AD-3
		Pediatric clip	S103-750	1563SD
		Pediatric soft	S103S-750	975PD-3
		Neonate Wrap	S303-750	940SD
		Multi-Site	S803-750	

Criticare Disposable Sensors

Models	Connector	Options	Part Number	OEM #
		Adult Box of 24	S503-050	570SD
		Pediatric Box of 24	S523-050	571SD
		Infant Box of 24	S533-050	572SD
		Neonate Box of 24	S543-050	573SD

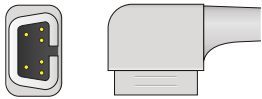

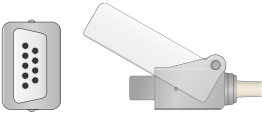
Criticare Adapter Cables

Models	Connector	Options	Part Number	OEM #
506 Spot CSI, 507SD, 503 Spot	<p>To Monitor:</p>  <p>To Criticare Sensor:</p> 	7 Foot Adapter	E708-750	518DD
Scholar, Poet (602-3A), 1100, 581, 508, 507, 507SD, 504, 503, 501; Mindray: 500A	<p>To Monitor:</p>  <p>To Criticare Sensor:</p> 	7 Foot Adapter	E708-050	518LD

Critikon Direct Connect Sensors

Models	Connector	Options	Part Number	OEM #
Dinamap 8700, 8710, 8720 Pulse, 8721, 9710, 9700, 8280 and Oxyshuttle		Adult Clip	S410-100	
		Adult Soft	S410S-100	
		Pediatric Clip	S110-100	
		Pediatric Soft	S110S-100	
		Neonate Wrap	S310-100	
		Multi-Site	S810-100	

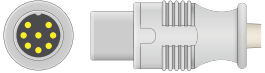
Datascope Direct Connect Sensors

Models	Connector	Options	Part Number	OEM #
Accusat, Accutorr 3 SAT, Accutorr 4 SAT, Accutorr Plus, Passport, Passport 2, Passport 2LT, Passport 5L, Passport IL, Passport EL, Passport XL, Passport XG, Datascope Multinex Plus Monitor, Datascope 3000, Passport D		Adult Clip	S410-070	0600-00-0026-02, 0020-00-071-01, 90651A-08
		Adult Soft	S410S-070	
		Pediatric Clip	S110-070	
		Pediatric Soft	S110S-070	
		Neonate Wrap	S310-070	
		Multi-Site	S810-070	
		Adult Clip	S410-290	0600-00-0094
		Adult Soft	S410S-290	
		Pediatric Clip	S110-290	
		Pediatric Soft	S110S-290	
		Neonate Wrap	S310-290	
		Multi-Site	S810-290	0600-00-0093

Datascope Short Sensors

Models	Connector	Options	Part Number	OEM #
Accusat, Accutorr 3 SAT, Accutorr 4 SAT, Accutorr Plus, Passport, Passport 2, Passport 2LT, Passport IL, Passport XL and Passport XG		Adult clip	S403-070	0600-00-0026-01
		Adult soft	S403S-070	
		Pediatric clip	S103-070	
		Pediatric soft	S103S-070	
		Neonate Wrap	S303-070	
		Multi-Site	S803-070	

Datascope Disposable Sensors

Models	Connector	Options	Part Number	OEM #
		Adult Box of 24	S503-070	0998-00-0076-05
		Pediatric Box of 24	S523-070	0998-00-0076-04
		Infant Box of 24	S533-070	0998-00-0074-03
		Neonate Box of 24	S543-070	0998-00-0074-04

Datascope Adapter Cables (Also see Masimo, Mindray and Nellcor)

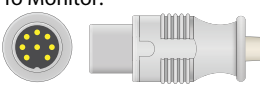
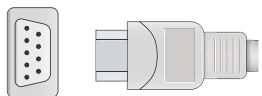
Models	Connector	Options	Part Number	OEM #
Accusat, Accutorr 3 SAT, Accutorr 4 SAT, Accutorr Plus, Passport, Passport 2, Passport 2LT, Passport IL, Passport XL and Passport XG	<p>To Monitor:</p>  <p>To Datascope Sensor:</p> 	7 Foot Adapter	E708-070	0012-00-0516-01, 0012-00-0516-02

Datex Ohmeda Direct Connect Sensors

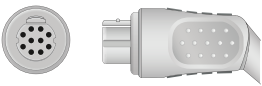
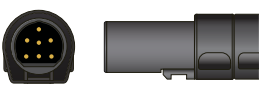
Models	Connector	Options	Part Number	OEM #
Aespire, Aespire 15, AS/3, AS/3 Compact, CS/3, S/5, S/5 Compact, CH/S, CH/2S, CH-RS, CG/2S, Cardiocap I, Cardiocap II, Cardiocap 5, Capnomac Ultima, Light Monitor, M-Estpr, Oscar II, OSP-200, Satellite Trans, Satellite, Satellite Plus II, Trans Plus, System 5, ULTS00, OXY-E4-N, ULTSIO, ULTSVI, ULTSVO		Adult Clip	S410-090	OXY-F4-N, SAF-F4, TS-F4-N
		Adult Soft	S410S-090	
		Pediatric Clip	S110-090	
		Pediatric Soft	S110S-090	
		Neonate Wrap	S310-090	OXY-W4-N
		Adult Ear Clip	S910-090	OXY-E4-N, TS-E4-N
		Multi-Site	S810-090	
3700, 3710, 3740, 3770, 3775, 3800, 4700, 5250 RGM, OxiCap, Biox 3740, Biox 3760, Rascal II, Datex Ohmeda TuffSat 3775, 37xx Series, 3800, 3900, 3900P, 4700 and 5250 respiratory gas monitors Cardiocap/5 with N-XOSAT option, S/5, AS/3, CS/3 Modular Monitors with M-OSAT module, Modulus CD; GE 7000 Series, Corometrics 511, TRAM A.R., OXY-W4-H, TRAM Modular x00SL Series, 200SL, 400SL, 600SL, 800A, 800SL; Mennen: Horizon XL800 (Ohmeda Sp02)		Adult Clip (9 Feet)	S410-020	OXY-F4-H, 6051-0000-035
		Adult Clip (3 Feet)	S403-020	OXY-F1-H, 6051-6000-155, TS-F1-H
		Adult Soft (9 Feet)	S410S-020	
		Pediatric Clip (9 Feet)	S110-020	
		Pediatric Soft (9 Feet)	S110S-020	
		Neonate Wrap (9 Feet)	S310-020	OXY-W4-H, 0380-1000-080, 0380-1000-081
		Adult Ear Clip (9 Feet)	S910-020	OXY-E4-H, 0380-1000-021, 6051-0000-188
		Multi-Site (9 Feet)	S810-020	







Datex Ohmeda Short Sensors

Models	Connector	Options	Part Number	OEM #
AS/3, CS/3, CH/S, CH/2S, CH-RS, SAF-F, CG/2S, Cardiocap I, Cardiocap II, Cardiocap 5, Capnomac Ultima, Light Monitor, M-Estpr, Oscar II, OSP-200, Satellite Trans, Satellite, Satellite Plus II, Trans Plus, System 5, ULTS00, ULTSIO, ULTSVI, ULTSVO		Adult clip	S403-090	OXY-F-DB, SAS-F
		Adult soft	S403S-090	
		Pediatric clip	S103-090	
		Pediatric soft	S103S-090	
		Neonate Wrap	S303-090	OXY-W-DB, SAS-W
		Adult Ear Clip	S903-090	OXY-E-DB, SAS-E
		Multi-Site	S803-090	

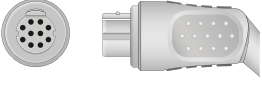
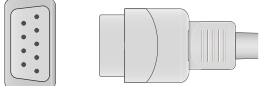
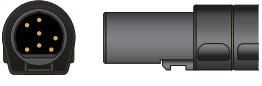

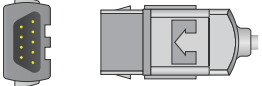

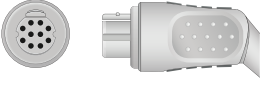





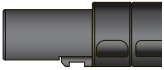

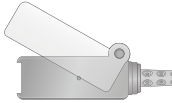
Datex Ohmeda Disposable Sensors

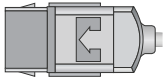
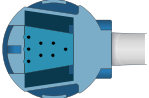
Models	Connector	Options	Part Number	OEM #
		Adult Box of 24	S503-090	SAS-AF
		Pediatric Box of 24	S523-090	SAS-AP
		Infant Box of 24	S533-090	SAS-AP
		Neonate Box of 24	S543-090	SAS-AF

Datex Ohmeda Adapter Cables

Models	Connector	Options	Part Number	OEM #
S/5, AS/3, CS/3 Modular Monitors with M-series modules, Cardiocap/5, Cardiocap S/5 Light Monitor, Capnomac Ultima, Satellite Plus II	<p>To Monitor:</p>  <p>To Datex Ohmeda DB9 Sensor:</p> 	7 Foot Adapter	E708-090	OXY-C3
	<p>To Monitor:</p>  <p>To GE TruSignal Sensor:</p> 	7 Foot Adapter	E708-1120	TS-H3
	<p>To Monitor:</p>  <p>To GE TruSignal Sensor:</p> 	7 Foot Adapter	E708-1160	TS-M3
	<p>To Monitor:</p>  <p>To GE TruSignal Sensor:</p> 	7 Foot Adapter	E708-1190	TS-N3

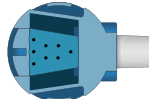
Datex Ohmeda Adapter Cables (Continued)

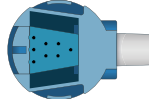
Models	Connector	Options	Part Number	OEM #
	<p>To Monitor:</p>   <p>To Datex Ohmeda DB9 Sensor:</p>  	7 Foot Adapter	E708-720	
Use TruSat monitors that require OxyTip+ sensors including Datex Ohmeda TruSat and Datex Ohmeda TruSat TD	<p>To Monitor:</p>   <p>To Datex Ohmeda OxyTip+ Sensor:</p> 	7 Foot Adapter	E708-1600	OXY-MC3
TuffSat, 3775, 37xx Series, 3800, 3900, 3900P, 4700 and 5250 respiratory gas monitors, Cardiocap/5 with N-XOSAT option, S/5, AS/3, CS/3 Modular Monitors with M-OSAT module	<p>To Monitor:</p>   <p>To GE TruSignal Sensor:"</p>  	7 Foot Adapter	E708-1020	OXY-OL3
Monitors that require OxyTip+ sensors including S/5, AS/3, CS/3 Modular Monitors with M-series modules, Cardiocap/5, Cardiocap S/5 Light Monitor, Capnomac Ultima, Satellite Plus II	<p>To Monitor:</p>   <p>To Datex Ohmeda OxyTip+ Sensor:</p> 	7 Foot Adapter	E708-2090	OXY-SL3
S/5, i4 Modular Monitors with E-series modules, Corometrics 259 with TruSignal technology	<p>To Monitor:</p>   <p>To Datex Ohmeda OxyTip+ Sensor:</p> 	7 Foot Adapter	E708-1210	OXY-ES3

Datex Ohmeda Adapter Cables (Continued)

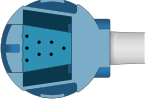

Models	Connector	Options	Part Number	OEM #
Use Oxytip, Oxy-C3 connectors	<p>To Monitor:</p>  <p>To Datex Ohmeda OxyTip+ Sensor:</p> 	7 Foot Adapter	E708-810	OXY-SLA, OXY-SLC

Dinamap (See Nellcor and Marquette)

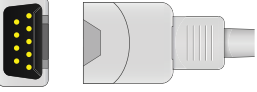
Dolphin Short Sensors

Models	Connector	Options	Part Number	OEM #
Dolphin ONE Oximeters 210, 2150, 2100, 2G00751		Adult clip	S403-50D0	201, 360, 360
		Adult soft	S403S-50D0	

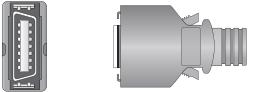
Dolphin Adapter Cables

Models	Connector	Options	Part Number	OEM #
	<p>To Monitor:</p>  <p>To Dolphin Sensor:</p> 	7 Foot Adapter	E708-500	





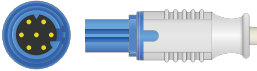

Drager Direct Connect Sensors

Models	Connector	Options	Part Number	OEM #
Siemens, Sirecust 700, Sirecust 630, Sirem SpO2 Module		Adult Clip	S410-330	
		Adult Soft	S410S-330	
		Pediatric Clip	S110-330	
		Pediatric Soft	S110S-330	
		Neonate Wrap	S310-330	
		Multi-Site	S810-330	

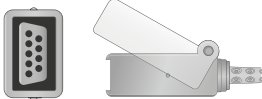
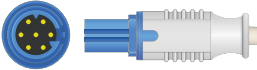
Drager Direct Connect Sensors (Continued)

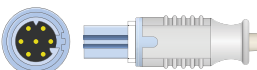
Models	Connector	Options	Part Number	OEM #
SC6002XL, 7000, SC8000, SC9000X, Infinity Vista and Infinity Delta		Adult Clip	S410-230	
		Adult Soft	S410S-230	
		Pediatric Clip	S110-230	
		Pediatric Soft	S110S-230	
		Neonate Wrap	S310-230	
		Multi-Site	S810-230	



Drager Adapter Cables

Models	Connector	Options	Part Number	OEM #
Sirecust 700, Sirecust 630, Sirem SpO2 Module	<p>To Monitor:</p>  <p>To Nellcor non-Oximax Sensor:</p> 	7 Foot Adapter	E708-330	
Infinity Vista, Delta, Gamma, Kappa MultiMed Pod; Siemens SC 6002XL, SC7000, SC8000, SC9000XL	<p>To Monitor:</p>  <p>To Nellcor non-Oximax Sensor:</p> 	7 Foot Adapter	E708-230	3368433, 3375834
Infinity Vista, Delta, Gamma and Kappa MultiMed Pod for Nellcor Oximax sensor	<p>To Monitor:</p>  <p>To Nellcor Oximax Sensor:</p> 	10 Foot Adapter	E710P-230	MS17330
Draeger monitors with Masimo SpO2 technology	<p>To Monitor:</p>  <p>To Masimo LNCS Sensor</p> 	7 Foot Adapter	E708M-230	MS17522

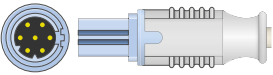
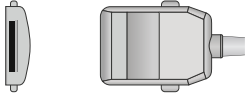
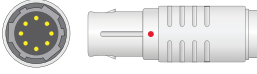
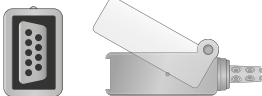

Drager Adapter Cables (Continued)

Models	Connector	Options	Part Number	OEM #
Infinity Vista, Delta, Gamma and Kappa MultiMed Pod	<p>To Monitor:</p>  <p>To Masimo LNOP Sensor:</p> 	7 Foot Adapter	E708M-23P0	MS17041
Vitalert 1000, Cicero, Julian	<p>To Monitor:</p>  <p>To Nellcor non-Oximax Sensor:</p> 	7 Foot Adapter	E708-280	M35371, M35370, 5720084



Edan Direct Connect Sensors (Also see Mindray)

Models	Connector	Options	Part Number	OEM #
M3, M3B, M8, M8A, M8B, M9, M9A, M50, M80, iM9, iM9A, iM50, iM80 with Oximax technology		Adult Clip	S410-191P0	
		Adult Soft	S410S-191P0	
		Pediatric Clip	S110-191P0	
		Pediatric Soft	S110S-191P0	
		Neonate Wrap	S310-191P0	
		Multi-Site	S810-191P0	
Digital Tech Sensors; Contec; Promed PM7000; Sinohero S80; Risingmed RPM9000C		Adult Clip	S410-46D0	
		Adult Soft	S410S-46D0	
		Pediatric Clip	S110-46D0	
		Pediatric Soft	S110S-46D0	
		Neonate Wrap	S310-46D0	
		Multi-Site	S810-46D0	



Edan Adapter Cables

Models	Connector	Options	Part Number	OEM #
M3, M3B, M8, M8A, M8B, M9, M9A, M50, M80, iM9, iM9A, iM50, iM80 with Oximax technology	<p>To Monitor:</p>  <p>To Nellcor Oximax Sensor:</p> 	7 Foot Adapter	E708P-1910	

Goldway Direct Connect Sensors

Models	Connector	Options	Part Number	OEM #
UT4000A, UT4000F, UT4000; Choice Electronics MMED6000DP		Adult Clip	S410-370	
		Adult Soft	S410S-370	
		Pediatric Clip	S110-370	
		Pediatric Soft	S110S-370	
		Neonate Wrap	S310-370	
		Multi-Site	S810-370	
Goldway monitors and DRE Spectra AG5		Adult Clip	S410-380	
		Adult Soft	S410S-380	
4000B		Adult Clip	S410-110	
		Adult Soft	S410S-110	
		Pediatric Clip	S110-110	
		Pediatric Soft	S110S-110	
		Neonate Wrap	S310-110	
		Multi-Site	S810-110	

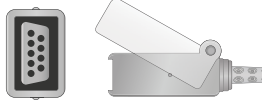
Goldway Adapter Cables

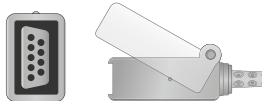
Models	Connector	Options	Part Number	OEM #
UT4000C, UT4000E, UT4000Apro, UT4000Fpro, UT6000A	To Monitor: 	7 Foot Adapter	E708-110	
	To Nellcor non-Oximax Sensor: 			
UT4000F, Pace Tech	To Monitor: 	7 Foot Adapter	E708-370	
	To Nellcor non-Oximax Sensor: 			

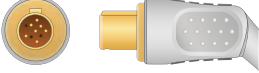

Hellige Direct Connect Sensors

Models	Connector	Options	Part Number	OEM #
Servomed 4 Generation SCP 844, 851, 852 SCS 804, SMK 151, 153, 154, 155-1, 156, 157, SMK181, 182, SMV 104T, 107, 111, 168, SMS316, SMC108, SMV104, Servomed N4, Servocard, Cardioserv Series, Vicom SM, SMU 511, 611, 612, 630, SMK-200, SMK210, 211, 230, 231, 240, 250, SMP 300, 310, Pepita 201, 202, 202 R, 203, Pepita 203, R204, 204R, 205, Pepita 205R		Adult Clip	S410-550	
		Adult Soft	S410S-550	
		Pediatric Clip	S110-550	
		Pediatric Soft	S110S-550	
		Neonate Wrap	S310-550	
		Multi-Site	S810-550	

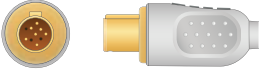
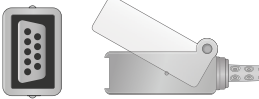

Hellige Adapter Cables

Models	Connector	Options	Part Number	OEM #
Cardioserv, Eagle 1000, Eagle 4000	To Monitor:  To Nellcor non-Oximax Sensor: 	7 Foot Adapter	E708-550	30344358

Infinium Direct Connect Sensors

Models	Connector	Options	Part Number	OEM #
OmniOne, Infinium Omni II, Infinium Infitron		Adult Clip	S410-97D0	
		Adult Soft	S410S-97D0	
		Pediatric Clip	S110-97D0	
		Pediatric Soft	S110S-97D0	
		Neonate Wrap	S310-97D0	
		Multi-Site	S810-97D0	
		Adult Clip	S410-137D0	
		Adult Soft	S410S-137D0	
		Pediatric Clip	S110-137D0	
		Pediatric Soft	S110S-137D0	
		Neonate Wrap	S310-137D0	
		Multi-Site	S810-137D0	
		Adult Clip	S410-1470	
		Adult Soft	S410S-1470	
		Pediatric Clip	S110-1470	
		Pediatric Soft	S110S-1470	
		Neonate Wrap	S310-1470	
		Multi-Site	S810-1470	

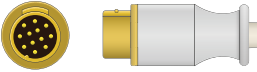



Infinium Adapter Cables

Models	Connector	Options	Part Number	OEM #
Mira, Vega; Larsen & Toubro (L&T): Planet 50	<p>To Monitor:</p>  <p>To Nellcor Oximax Sensor:</p> 	10 Foot Adapter	E710P-830	



Invivo Direct Connect Sensors

Models	Connector	Options	Part Number	OEM #
4500, 4500 Plus, Millennia, Omega 1445, Omni-Trak TVS, Sat Scout		Adult Clip	S410-140	9383
		Adult Soft	S410S-140	
		Pediatric Clip	S110-140	
		Pediatric Soft	S110S-140	
		Neonate Wrap	S310-140	
		Multi-Site	S810-140	

Invivo Adapter Cables

Models	Connector	Options	Part Number	OEM #
4500 Plus, 4500 Plus 3, Millennia, Omega14 45, Omni-TrakTVS, Sat Scout	<p>To Monitor:</p>  <p>To Nellcor non-Oximax Sensor:</p> 	7 Foot Adapter	E708-140	9383
M8, M12	<p>To Monitor:</p>  <p>To Nellcor non-Oximax Sensor:</p> 	7 Foot Adapter	E708-14M0	

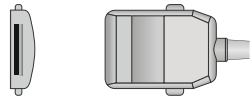
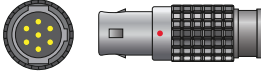
Invivo Adapter Cables (Continued)

Models	Connector	Options	Part Number	OEM #
M8, M12, Escort M with Masimo technology	<p>To Monitor:</p>  <p>To Masimo LNOP Sensor:</p> 	7 Foot Adapter	E708M-14P0	9217A, 9289A, 9289B, 9217B
M8, M12 with Masimo technology	<p>To Monitor:</p>  <p>To Masimo LNCS Sensor:</p> 	7 Foot Adapter	E708M-140	



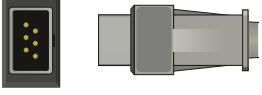

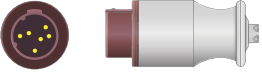

Konica Minolta Short Sensors

Models	Connector	Options	Part Number	OEM #
Pulsox-300, Pulsox-300i and Check Probe SP5C		Adult Clip	S401-1050	R124P50
		Adult Soft	S401S-1050	
		Pediatric Clip	S101-1050	
		Pediatric Soft	S101S-1050	
		Neonate Wrap	S301-1050	
		Multi-Site	S801-1050	

Kontron Direct Connect Sensors

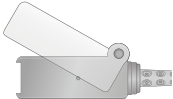
Models	Connector	Options	Part Number	OEM #
7138, 7840, 7845, Minimon 7137 and 7337, Micromon, Supermon, Kolormon, Trakmon		Adult Clip	S410-130	608010
		Adult Soft	S410S-130	
		Pediatric Clip	S110-130	
		Pediatric Soft	S110S-130	
		Neonate Wrap	S310-130	
		Multi-Site	S810-130	

Kontron Adapter Cables

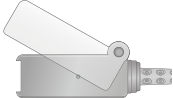
Models	Connector	Options	Part Number	OEM #
	<p>To Monitor:</p>   <p>To Nellcor non-Oximax Sensor:</p>  	7 Foot Adapter	E708-130	
	<p>To Monitor:</p>   <p>To Nellcor non-Oximax Sensor:</p>  	7 Foot Adapter	E708-530	

Lohmeier Direct Connect Sensors

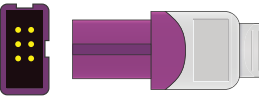
Models	Connector	Options	Part Number	OEM #
M010		Adult Clip	S410-640	6051-0000-035
		Adult Soft	S410S-640	
		Pediatric Clip	S110-640	
		Pediatric Soft	S110S-640	
		Neonate Wrap	S310-640	
		Multi-Site	S810-640	



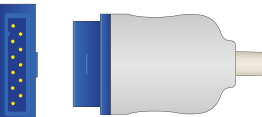
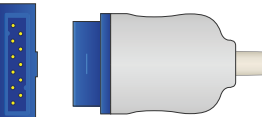

Marquette (GE) Direct Connect Sensors

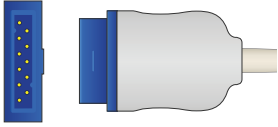
Models	Connector	Options	Part Number	OEM #
Eagle, Dash, Solar Series, GE Responder 2000, Responder 3000 and Series Tram Modular x50SL with Nellcor technology		Adult Clip	S410-210	407705-006
		Adult Soft	S410S-210	
		Pediatric Clip	S110-210	
		Pediatric Soft	S110S-210	
		Neonate Wrap	S310-210	
		Multi-Site	S810-210	
Corometrics 250cx and Marquette monitors with Oximax technology		Adult Clip	S410-21P0	2025350-001, 2021406-001
		Adult Soft	S410S-21P0	
		Pediatric Clip	S110-21P0	
		Pediatric Soft	S110S-21P0	
		Neonate Wrap	S310-21P0	
		Multi-Site	S810-21P0	

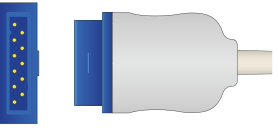
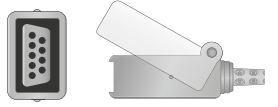
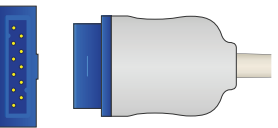
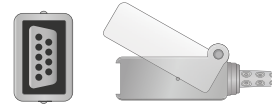
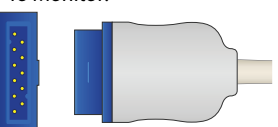

Marquette (GE) Direct Connect Sensors (Continued)

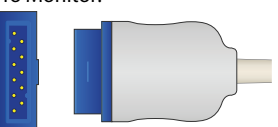
Models	Connector	Options	Part Number	OEM #
Dash 2000, 3000, 4000, 5000, i/9500 (Tram 451N5/851N5). Solar 7000, 8000 e Eagle 1000, 3000, Smk SMV, Corometrics 250 with Masimo technology		Adult Clip	S410-21M0	TS-F2-GE, TS-F4-GE
		Adult Soft	S410S-21M0	TS-SA4-GE
		Pediatric Clip	S110-21M0	
		Pediatric Soft	S110S-21M0	
		Neonate Wrap	S310-21M0	
		Multi-Site	S810-21M0	

Marquette (GE) Adapter Cables

Models	Connector	Options	Part Number	OEM #
Eagle, Dash, SOLAR, TRAM Modular and x50SL Series, GE Carescape Dinamap V100 with Nellcor technology, Corometrics TRAM 450SL, Corometrics 0128 without Oximax technology	<p>To Monitor:</p>  <p>To Nellcor non-Oximax Sensor:</p> 	7 Foot Adapter	E708-210	2006644-001, 407252-002, E9004DE, TE2423, CB-A400-1102A
For use on monitors with the Oximax Sp02 module for use with non-Oximax sensors	<p>To Monitor:</p>  <p>To Nellcor non-Oximax Sensor:</p> 	7 Foot Adapter	E708-21P0	
GE Carescape Dinamap V100, Dash 3000, Dash 4000, Dash 5000, Solar 8000, Solar 8000M, i9500 with Tram module 451N5/851N5, GE 250CX, Corometrics 250, GE Corometrics 259 Fetal Monitor with Oximax technology	<p>To Monitor:</p>  <p>To Nellcor Oximax Sensor:</p> 	7 Foot Adapter	E710P-210	2021406-001, 2025350-001, 20221406-001
Dash, Solar, Carescape Dinamap V100 with Masimo technology	<p>To Monitor:</p>  <p>To Nellcor non-Oximax Sensor:</p> 	7 Foot Adapter	E708-21M0	

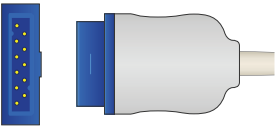
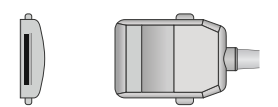
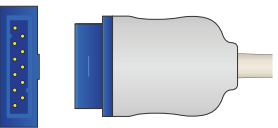
Marquette (GE) Adapter Cables (Continued)

Models	Connector	Options	Part Number	OEM #
Corometrics 250, Corometrics 259, Dash 3000, Dash, 4000, Dash 5000 with Masimo option, Solar 8000/8000M, i/9500 with Tram Module 451M/851M, CardioLab/Mac-Lab with Tram Module 451M, Datex Ohmeda Giraffe Infant Warmer	<p>To Monitor:</p>  <p>To Masimo LNOP Sensor:</p> 	7 Foot Adapter	E708M-21P0	2017002-00, 2017002-001, 2017002-003, 2016041-00, 2016041-01, 2016041-02, PC-12-GE 1890
Dash, Solar, Carescape Dinamap V100 with Masimo technology	<p>To Monitor:</p>  <p>To Masimo LNCS Sensor:</p> 	7 Foot Adapter	E708M-210	LNC-10-GE 2016, 2027263-002, PS-10153D

Masimo Direct Connect Sensors

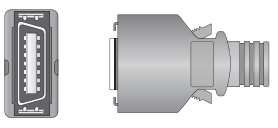
Models	Connector	Options	Part Number	OEM #
		Adult Clip	S410-150	DC-8 2387, 2027277-001, 01-02-0730, 01-02-0712, 0600-00-0120
		Adult Soft	S410S-150	DBI-DC8 2653
		Pediatric Clip	S110-150	
		Pediatric Soft	S110S-150	
		Neonate Wrap	S310-150	
		Multi-Site	S810-150	

Masimo Short Sensors

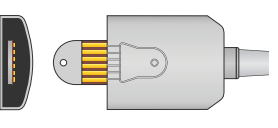
Models	Connector	Options	Part Number	OEM #
Masimo LNOP Sensor		Adult Clip	S403-1250	1269 LNOP DCI, 0600-00-0047, 7270312, 2002800-001, 9898031 40321, 690-0230-00
		Adult Soft	S403S-1250	
		Pediatric Clip	S103-1250	1276 LNOP DCIP, 0600-00-0063, 7270304, 2002799-001, 9898031 40331, 690-0231-00
		Pediatric Soft	S103S-1250	
		Neonate Wrap	S303-1250	
		Adult Ear Clip	S903-1250	2027274-001, 9898031 40341
		Multi-Site	S803-1250	1544 LNOP YI, 0600-00-0078, 7497014, 2010463-001, 690-0232-00

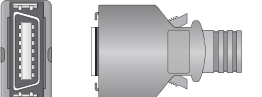

Masimo Short Sensors (Continued)

Models	Connector	Options	Part Number	OEM #
Masimo LNCS Sensor		Adult Clip	S403-490	1863 LNCS DCI, 0010-10-42600, 0600-00-0126, MP00796, 9898031 48281, 01-02-0905, 2.100309, 2027258-001, 8000-0294
		Adult Soft	S403S-490	2653 LNCS DBI
		Pediatric Clip	S103-490	1864 LNCS DCIP, 01-02-0906, 0010-10-42634, 0600-00-0127, MP00795, 9898031 48291, 2027259-001
		Pediatric Soft	S103S-490	
		Neonate Wrap	S303-490	
		Adult Ear Clip	S903-490	1895 LNCS TC-I, 2027261-001, 9898031 48301
		Multi-Site	S803-490	2258 LNCS YI, MP00789
		Adult Clip	S402-150	LNOP DCSC 1396, 01-02-0700

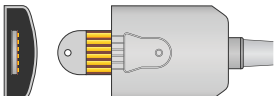
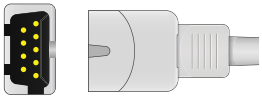









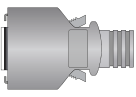

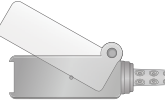

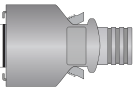
Masimo Disposable Sensors

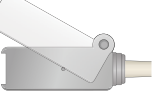
Models	Connector	Options	Part Number	OEM #
LNOP disposable sensor		Adult Box of 24	S503-1250	LNOP Amtx
		Pediatric Box of 24	S523-1250	LNOP Pmtx
		Infant Box of 24	S533-1250	LNOP INF
		Neonate Box of 24	S543-1250	LNOP Neo
		Adult Box of 24	S503-490	1859 LNCS Amtx, 2027253-001
		Pediatric Box of 24	S523-490	1860 LNCS Pmtx, 2027254-001
		Infant Box of 24	S533-490	2328 LNCS INF, 2027255-001, 1777, 2319
		Neonate Box of 24	S543-490	2329 LNCS Neo, 2027256-001, 2320

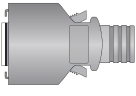

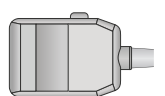
Masimo Adapter Cables

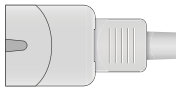
Models	Connector	Options	Part Number	OEM #
All Masimo; MDE: Escort II OPT30; Prism; GE Marquette: Pro1000, V300; Invivo: T8; Schiller; Zoll; Datascope: Trio, Passport 2, Spectrum	<p>To Monitor:</p> 	4 Foot Adapter	E704M-490	LNC-4-Ext, 2021, 01-02-0715
		7 Foot Adapter	E708M-490	LNC MAC-180, 2268, 8000-0325
	<p>To Masimo LNCS Sensor:</p> 			

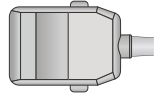
Masimo Adapter Cables (Continued)



Models	Connector	Options	Part Number	OEM #
Masimo adapter cable for use with Nellcor non-Oximax sensors	<p>To Monitor:</p>   <p>To Nellcor non-Oximax Sensor:</p>  	7 Foot Adapter	E708-150	
Datascope Accutorr V, Duo, Passport 2, Passport 2LT, Passport V, Spectrum, Spectrum OR, Trio, V12, V21; Medtronic Physio Control: Lifepak 11, Lifepak 12, Lifepak 15, Lifepak 20; Welch Allyn: Spot Vital Signs 42MTB-E1, 45NE0-E1 LX; Zoll: E Series, M Series, R Series	<p>To Monitor:</p>   <p>To Masimo LNCS Sensor:</p>  	1 Foot Adapter	E701M-150	LNC-1 2364
		4 Foot Adapter	E704M-150	LNC-4 2017, 01-02-0903
		7 Foot Adapter	E708M-150	0012-00-1652, 0012-00-1653, 0012-00-1599, 2027263-001
		10 Foot Adapter	E710M-150	LNC-10 1814, 01-02-0904
Equipment that require LNOP-type sensors including the Atom V-2100G incubator	<p>To Monitor:</p>   <p>To Masimo LNOP Sensor:</p>  	4 Foot Adapter	E704M-15P0	PC04 1173
		8 Foot Adapter	E708M-15P0	PC08 1005, 0012-00-1099-01, 0012-00-1099-02, 2009743-001, 2027278-001, 01-02-0182, 01-02-0192, 01-02-0445
		12 Foot Adapter	E711M-15P0	PC12 1006
Datascope: Accutorr V, Duo, Passport 2, Passport V, Spectrum, Spectrum OR, Trio, V12, V21	<p>To Monitor:</p>   <p>To Masimo LNOP Sensor:</p>  	4 Foot Adapter	E704M-49P0	MAC-1 1927, 0012-00-1656

Meditech Direct Connect Sensors

Models	Connector	Options	Part Number	OEM #
D3D, G3C, G3F, G3H, G3L	 	Adult Clip	S410-65D0	
		Adult Soft	S410S-65D0	
		Pediatric Clip	S110-65D0	
		Pediatric Soft	S110S-65D0	
		Neonate Wrap	S310-65D0	
		Multi-Site	S810-65D0	

Medtronic (See Masimo and Nellcor Adapter Cables)

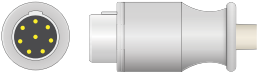
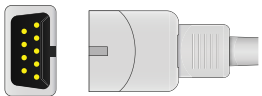
MEK Direct Connect Sensors

Models	Connector	Options	Part Number	OEM #
New MEK monitors		Adult Clip	S410-560	
		Adult Soft	S410S-560	
		Neonate Wrap	S310-560	
MP 100, MP 110, MP 400, MP 500, MP 600, MP 1000; Votem VP-700, VP-1000, VP-1200		Adult Clip	S410-260	
		Adult Soft	S410S-260	
		Pediatric Clip	S110-260	
		Pediatric Soft	S110S-260	
		Neonate Wrap	S310-260	
		Multi-Site	S810-260	
MP 7000		Adult Clip	S410-270	
		Adult Soft	S410S-270	
		Pediatric Clip	S110-270	
		Pediatric Soft	S110S-270	
		Neonate Wrap	S310-270	
		Multi-Site	S810-270	

MEK Short Sensors

Models	Connector	Options	Part Number	OEM #
MP100, MP110, MP400, MP500, MP600, and MP1000		Adult clip	S403-260	
		Adult soft	S403S-260	
		Pediatric clip	S103-260	
		Pediatric soft	S103S-260	
		Neonate Wrap	S303-260	
		Multi-Site	S803-260	

MEK Disposable Sensors

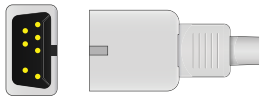
Models	Connector	Options	Part Number	OEM #
		Adult Box of 24	S503-260	
		Pediatric Box of 24	S523-260	
		Infant Box of 24	S533-260	
		Neonate Box of 24	S543-260	

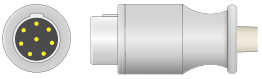
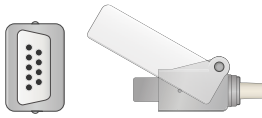

MEK Adapter Cables

Models	Connector	Options	Part Number	OEM #
	<p>To Monitor:</p>  <p>To Nellcor non-Oximax Sensor:</p> 	7 Foot Adapter	E708-560	

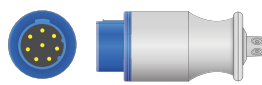
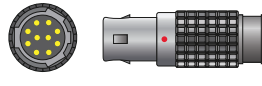

Mennen Direct Connect Sensors

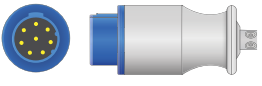
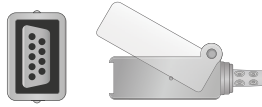
Models	Connector	Options	Part Number	OEM #
		Adult Clip	S410-540	
		Adult Soft	S410S-540	
		Pediatric Clip	S110-540	
		Pediatric Soft	S110S-540	
		Neonate Wrap	S310-540	
		Multi-Site	S810-540	
Horizon 2000		Adult Clip	S410-240	
		Adult Soft	S410S-240	
		Pediatric Clip	S110-240	
		Pediatric Soft	S110S-240	
		Neonate Wrap	S310-240	
		Multi-Site	S810-240	

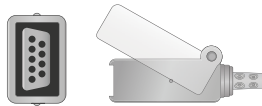

Mennen Adapter Cables

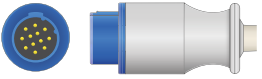
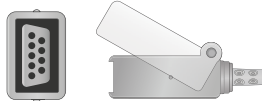
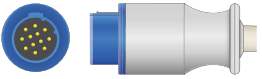
Models	Connector	Options	Part Number	OEM #
	<p>To Monitor:</p>  <p>To Nellcor non-Oximax Sensor:</p> 	7 Foot Adapter	E708-540	
	<p>To Monitor:</p>  <p>To Nellcor non-Oximax Sensor:</p> 	7 Foot Adapter	E708-240	261-877-070

Mennen Adapter Cables (Continued)

Models	Connector	Options	Part Number	OEM #
	<p>To Monitor:</p>  <p>To Nellcor non-Oximax Sensor:</p> 	7 Foot Adapter	E708-59M0	551-306-321
	<p>To Monitor:</p>  <p>To Nellcor non-Oximax Sensor:</p> 	7 Foot Adapter	E708M-590	

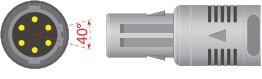

Mindray Direct Connect Sensors

Models	Connector	Options	Part Number	OEM #
PM 600, PM 6000 (New), PM 7000, 6201, PM 8000, PM 9000, PM 9000 Express, MEC 100, MEC 200, MEC 1000, MEC 1200, 809B, VS 800; Mennen Enmove 1000, Mercury; Kontron: 7138, 7840, 7845; Medec: MEDEC-1000, M-1000, M-1100; Creative: PC9000, UP6000; Edan: M3, M3A, M3B, M8, M8A, M8B, M9, M9A, M50, M80, iM8, iM8A, iM8B, iM9, iM9A, iM50, iM80; Goldway, Contec and Danatech, Penlon Intermed PM 8000		Adult Clip	S410-290	
		Adult Soft	S410S-290	
		Pediatric Clip	S110-290	
		Pediatric Soft	S110S-290	
		Neonate Wrap	S310-290	
		Multi-Site	S810-290	
PM 6000, PM 6201, PM 7000, PM 8000, PM 9000 Express, PM 9000, PM 9100, PM 9200P, M1K0, M2K0 (before January 2006) with Masimo technology		Adult Clip	S410-30M0	
		Adult Soft	S410S-30M0	
		Pediatric Clip	S110-30M0	
		Pediatric Soft	S110S-30M0	
		Neonate Wrap	S310-30M0	
PM 6000 and PM 8000 with Masimo technology		Adult Clip	S410-29M0	
		Adult Soft	S410S-29M0	
		Pediatric Clip	S110-29M0	
		Pediatric Soft	S110S-29M0	
		Neonate Wrap	S310-29M0	
		Multi-Site	S810-29M0	

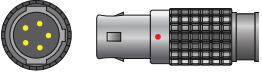
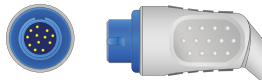
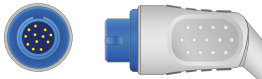
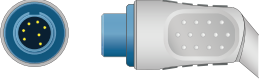





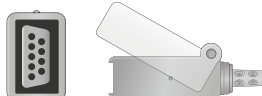

Mindray Direct Connect Sensors (Continued)

Models	Connector	Options	Part Number	OEM #
503, 507, 508, 509, Mindray PM 9000 with Criticare technology		Adult Clip	S410-310	
		Adult Soft	S410S-310	
		Pediatric Clip	S110-310	
		Pediatric Soft	S110S-310	
		Neonate Wrap	S310-310	
		Multi-Site	S810-310	
PM 5000, PM 6000, PM 8000		Adult Clip	S410-220	
		Adult Soft	S410S-220	
		Pediatric Clip	S110-220	
		Pediatric Soft	S110S-220	
		Neonate Wrap	S310-220	
PM 6000 with Masimo technology		Adult Clip	S410-22M0	
		Adult Soft	S410S-22M0	
		Pediatric Clip	S110-22M0	
		Pediatric Soft	S110S-22M0	
		Neonate Wrap	S310-22M0	
		Multi-Site	S810-22M0	
BeneView T5, T8 and iPM-8900		Adult Clip	S410-480	
		Adult Soft	S410S-480	
		Pediatric Clip	S110-480	
		Pediatric Soft	S110S-480	
		Neonate Wrap	S310-480	
Multi-Site	S810-480			





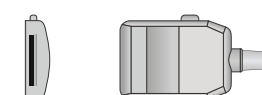

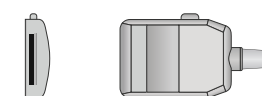

Mindray Adapter Cables

Models	Connector	Options	Part Number	OEM #
MEC 100, MEC 200, PM 7000, 6201, PM 8000, PM 9000, VS-800, Datascope Trio, Accutorr V, Passport V	<p>To Monitor:</p>  <p>To Nellcor non-Oximax Sensor:</p> 	7 Foot Adapter	E708-290	0010-20-42594





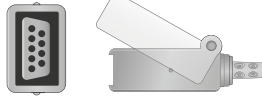



Mindray Adapter Cables (Continued)

Models	Connector	Options	Part Number	OEM #
VS 800, PM 7000, PM 8000, PM 9000 Series and New PM 6000	<p>To Monitor:</p>  <p>To Nellcor non-Oximax Sensor:</p> 	7 Foot Adapter	E708-30M0	
Trio, Mindray PM 7000, PM 9000	<p>To Monitor:</p>  <p>To Nellcor Oximax Sensor:</p> 	10 Foot Adapter	E710P-1800	
	<p>To Monitor:</p>  <p>To Nellcor Oximax Sensor:</p> 	10 Foot Adapter	E710P-1840	0010-20-42595
VS 800, PM 7000, PM 8000, PM 9000 Series and New PM 6000 with Masimo technology	<p>To Monitor:</p>  <p>To Masimo LNOP Sensor:</p> 	7 Foot Adapter	E708M-29P0	9200-30-10707
VS 800, PM 7000, PM 8000, PM 9000 Series and New PM 6000 with Masimo technology	<p>To Monitor:</p>  <p>To Masimo LNOP Sensor:</p> 	7 Foot Adapter	E708M-30P0	

Mindray Adapter Cables (Continued)

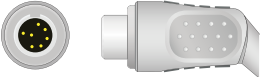
Models	Connector	Options	Part Number	OEM #
VS 800, PM 7000, PM 8000, PM 9000 Series and New PM 6000.	<p>To Monitor:</p>  <p>To Masimo LNCS Sensor:</p> 	7 Foot Adapter	E708M-300	0010-30-42625, 9200-30-10682
MEC-509, 509+, 503, 507	<p>To Monitor:</p>  <p>To Nellcor non-Oximax Sensor:</p> 	7 Foot Adapter	E708-310	512A-30-0607
PM 5000, PM 6000, PM 8100	<p>To Monitor:</p>  <p>To Nellcor non-Oximax Sensor:</p> 	7 Foot Adapter	E708-220	0010-30-42737, 0010-20-42710
PM 6000 with Masimo technology	<p>To Monitor:</p>  <p>To Nellcor non-Oximax Sensor:</p> 	7 Foot Adapter	E708-22M0	
PM 6000 with Masimo technology	<p>To Monitor:</p>  <p>To Masimo LNCS Sensor:</p> 	7 Foot Adapter	E708M-220	0010-30-12452

Mindray Adapter Cables (Continued)

Models	Connector	Options	Part Number	OEM #
BeneView T5, T8, PM 6800 without Oximax and Penlon Intermed Patient Monitors	<p>To Monitor:</p>  <p>To Nellcor non-Oximax Sensor:</p> 	7 Foot Adapter	E708-480	0010-20-42710
BeneView T5 and T8 with Oximax technology	<p>To Monitor:</p>  <p>To Nellcor Oximax Sensor:</p> 	10 Foot Adapter	E710P-480	0010-20-42712
T5, T8 and Penlon Intermed patient monitors with Masimo technology	<p>To Monitor:</p>  <p>To Nellcor non-Oximax Sensor:</p> 	7 Foot Adapter	E708-48M0	0010-30-42738
BeneView T5 and T8	<p>To Monitor:</p>  <p>To Masimo LNCS Sensor:</p> 	7 Foot Adapter	E708M-480	0010-30-42738

Nellcor Direct Connect Sensors

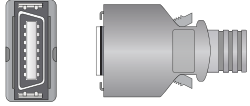
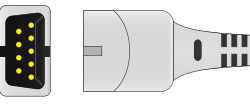
Models	Connector	Options	Part Number	OEM #
Datascope: Accutorr Plus (Nellcor); Invivo: MDE Prism Escort; Nellcor: NPB 290, NPB 295, N 390, N 395, N 3000, N 6000; Nihon Kohden: BSM-4104A, BSM-4114A and Colin Press Mate, Prodigy, BP88/306, BP885		Adult Clip	S410-690	
		Adult Soft	S410S-690	
		Pediatric Clip	S110-690	
		Pediatric Soft	S110S-690	
		Neonate Wrap	S310-690	
		Multi-Site	S810-690	
		Adult Clip	S410-010	
		Adult Soft	S410S-010	
		Pediatric Clip	S110-010	
		Pediatric Soft	S110S-010	
		Neonate Wrap	S310-010	
		Multi-Site	S810-010	

Nellcor Short Sensors

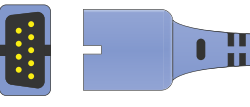
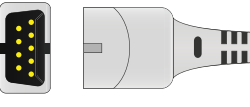
Models	Connector	Options	Part Number	OEM #
All monitors with Nellcor Oximax SpO2 technology		Adult Clip	S403-01P0	DS100A
		Adult Soft	S403S-01P0	OXI-A/N
		Pediatric Clip	S103-01P0	OXI-P/I
		Pediatric Soft	S103S-01P0	
		Neonate Wrap	S303-01P0	
		Adult Ear Clip	S903-01P0	
		Multi-Site	S803-01P0	D-YS
Older Oxi-Smart monitors that require sensors without Oximax technology		Adult Clip	S403-010	F-3212-9, 06-00-1074, 512E-30-90390, 512F-30-28263, M1196T, 512D-30-90200, 2023211-001
		Adult Soft	S403S-010	M1191T, 512E-30-90390
		Pediatric Clip	S103-010	512G-30-90607, 512H-30-79061, 512H-30-79061
		Pediatric Soft	S103S-010	M1192T, 512G-30-90607
		Neonate Wrap	S303-010	M1193T
		Multi-Site	S803-010	518B-30-7210, 2023215-001, 518B-30-72107



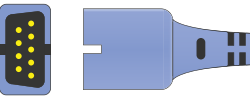

Nellcor Disposable Sensors

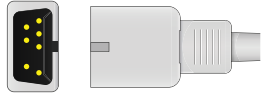
Models	Connector	Options	Part Number	OEM #
All monitors with Nellcor Oximax technology		Adult Box of 24	S503-01P0	MAX-A, 70124027, MX50065
		Pediatric Box of 24	S523-01P0	MAX-P, 70124022, MX50066
		Infant Box of 24	S533-01P0	MAX-I, 70124026, MX50067
		Neonate Box of 24	S543-01P0	MAX-N, 70124032, MX50068

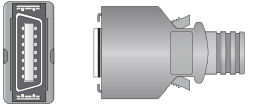
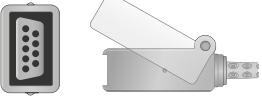
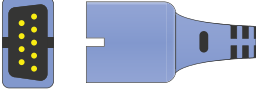

Nellcor Disposable Sensors (Continued)

Models	Connector	Options	Part Number	OEM #
Older Oxi-Smart monitors that require sensors without Oximax technology		Adult Box of 24	S503-010	D25, 2023217-001, M1131A
		Pediatric Box of 24	S523-010	D20
		Infant Box of 24	S533-010	I20, M1132A
		Neonate Box of 24	S543-010	N25, 2023216-001, M1133A, M1134A

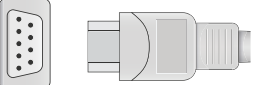

Nellcor Adapter Cables

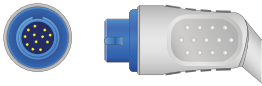
Models	Connector	Options	Part Number	OEM #
Colin: BP88/306; Critikon Dinamap ProCare, Pro Series, Pro 300, Pro 1000, M-NSAT Modules; Datascope: Accutorr Plus, Duo, Passport 2, Passport XG, Spectrum, Trio; Nellcor: NPB-290, NPB-295, N-390, N-395, N-3000, N-6000, NPB-290, NPB-295, N-390, N-395, N-3000, N-6000; Nihon Kohden: BSM-2300, BSM-4100, BSM-5100, BSM-4104A, BSM-4114A; Ohmeda enGuard CMS; Physio Control Lifepak 12	<p>To Monitor:</p>  <p>To Nellcor non-Oximax Sensor:</p> 	7 Foot Adapter	E708-690	SCP-10, MC-10, 200012-00-1254, NK-SCP-10, 0012-00-1254, 903131
NBP-195; Colin; GE Dinamap Compact Dinamap MPS; All Welch Allyn	<p>To Monitor:</p>  <p>To Nellcor Oximax Sensor:</p> 	4 Foot Adapter	E704-710	DEC-04
		7 Foot Adapter	E708-710	DEC-08, NON-UNI-EXT-3, EC8
		10 Foot Adapter	E710-710	DEC-10
N-595 and N-600; CAS Med 511 Apnea Monitor; Cardell Veterinary 9403, 9500HD; Colin BP-S510 and T105NXM; Digicare LW600; Dinamap Carescape V100, ProCare, Pro Series, ProSeries V2, Pro 300, Pro 1000, Pro 1000 V3, E-NSAT Modules for i4 Modular Monitors with Oximax option; Fukuda Denshi DS-7100; GE Procure; Welch Allyn Spot Vital Signs 42NTB-E1, 42NT0-E1 LXI	<p>To Monitor:</p>  <p>To Nellcor Oximax Sensor:</p> 	10 Foot Adapter	E710-700	DOC-10, WA-DOC-10, 0012-00-1464, 01-02-0183, 2008773-001, 2021406-002
N-100, N-200, N-1000 and N-2000 Preamp cable; MDE Escort E100, Drager VitAlert 3200	<p>To Monitor:</p>  <p>To Nellcor non-Oximax Sensor:</p> 	10 Foot Adapter	E710-850	M-200-13, C-13-200

Newtech Direct Connect Sensors

Models	Connector	Options	Part Number	OEM #
NT3A		Adult Clip	S410-173D0	
		Adult Soft	S410S-173D0	
		Pediatric Clip	S110-173D0	
		Pediatric Soft	S110S-173D0	
		Neonate Wrap	S310-173D0	
		Multi-Site	S810-173D0	
NT2A		Adult Clip	S410-165D0	
		Adult Soft	S410S-165D0	
		Pediatric Clip	S110-165D0	
		Pediatric Soft	S110S-165D0	
		Neonate Wrap	S310-165D0	
		Multi-Site	S810-165D0	

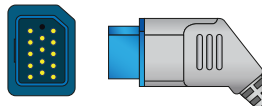
Nihon Kohden Direct Connect Sensors

Models	Connector	Options	Part Number	OEM #
AL-800PA Module, BSM-1101 Life Scope EC, BSM-2101/2 Life Scope L, BSM-3101 Life Scope LC, BSM-7100/7200 Life Scope 8, BSM-8200/1 Life Scope 12, BSM-8301/2 Life Scope 9, SM-8800 Life Scope 14, OLV-1100A, NT3B		Adult Clip	S410-160	
		Adult Soft	S410S-160	
		Pediatric Clip	S110-160	
		Pediatric Soft	S110S-160	
		Neonate Wrap	S310-160	
		Multi-Site	S810-160	
BSM-4101, BSM-4102, BSM-4102A, 4103, 4111, 4113 Life Scope P, BSM-5105, 5135 Life Scope A, BSM-2351, 2353 Life Scope L, BSM-2301, 2303 Life Scope I, Life Scope J, BSM-9101 and PVM-2701		Adult Clip	S410-360	TL-201T
		Adult Soft	S410S-360	
		Pediatric Clip	S110-360	
		Pediatric Soft	S110S-360	
		Neonate Wrap	S310-360	
		Multi-Site	S810-360	
		Adult Clip	S410-1060	
		Adult Soft	S410S-1060	
		Pediatric Clip	S110-1060	
		Pediatric Soft	S110S-1060	
		Neonate Wrap	S310-1060	
		Multi-Site	S810-1060	



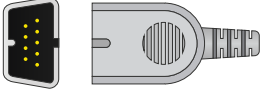

Nihon Kohden Short Sensors

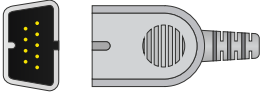
Models	Connector	Options	Part Number	OEM #
BSM-2300 Life Scope I, BSM-2301, MSM 2301K, 2303 Life Scope I, 2303K, BSM 2350 Life Scope L, BSM-2351, 2353 Life Scope L, BSM-4100 Life Scope P, BSM 4101, 4103 TL-101T, 4111, 4113 Life Scope P, BSM-5100 Life Scope A, BSM-5105, 5135 Life Scope A, Life Scope TR, BSM-6000 series, BSM-6301K, BSM-6501K, BSM-6701K, BSM-9510 Life Scope M, BSM-9800 Life Scope S, Oxipal P225F		Adult Clip	S405-160	TL-101T, TL-201T
		Adult Soft	S405S-160	
		Pediatric Clip	S105-160	
		Pediatric Soft	S105S-160	
		Neonate Wrap	S305-160	
		Multi-Site	S805-160	TL-220T, TL-260T

Nihon Kohden Disposable Sensors

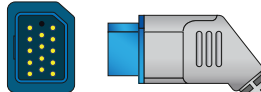
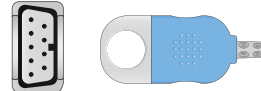
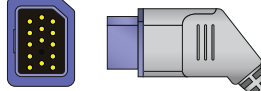
Models	Connector	Options	Part Number	OEM #
		Adult Box of 24	S503-160	TL-251T, TL-271T3
		Pediatric Box of 24	S523-160	TL-252T, TL-272T3
		Infant Box of 24	S533-160	TL-252T
		Neonate Box of 24	S543-160	TL-253T, TL-273T3

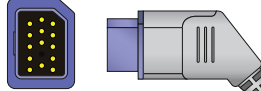

Nihon Kohden Adapter Cables

Models	Connector	Options	Part Number	OEM #
BSM-2300 Life Scope I, BSM-2301A, BSM-2351, 2353 Life Scope L, BSM-2301, 2303 Life Scope I, BSM-4100 Life Scope P, BSM-4101, 4103, 4111, 4113 Life Scope P, BSM-5100 Life Scope A, BSM-5105, 5135 Life Scope A, Life Scope TR, BSM-6000 series, BSM-6301K, BSM-6501K, BSM-6701K, BSM-9510 Life Scope M, BSM-9800 Life Scope S	<p>To Monitor:</p>  <p>To Nihon Kohden Sensor:</p> 	10 Foot Adapter	E710-360	JL-900P
BSM-6313, BSM-6333, BSM-6533, BSM-6573, BSM-6733, BSM-6773, BSM-9173	<p>To Monitor:</p>  <p>To Masimo LNCS Sensor:</p> 	10 Foot Adapter	E710M-360	JL-631P
Life Scope TR, BSM-6000 series, BSM-6310K, BSM-6501K, BSM-6701K and AY-651P and AY-653P modules	<p>To Monitor:</p>  <p>To Nellcor Oximax Sensor:</p> 	10 Foot Adapter	E710P-360	JL-650P

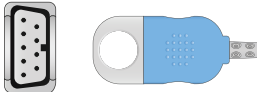
Nihon Kohden Adapter Cables (Continued)

Models	Connector	Options	Part Number	OEM #
OPV-1500 Life Scope N	<p>To Monitor:</p>  <p>To Nihon Kohden Sensor:</p> 	10 Foot Adapter	E710-1060	JL-302T

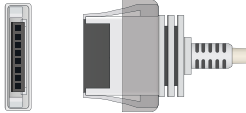
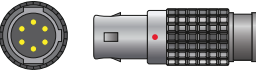
Nonin Direct Connect Sensors

Models	Connector	Options	Part Number	OEM #
8600, 8500, 8700, 8800, 96, 009 and 700		Adult Clip	S410-280	
		Adult Soft	S410S-280	
		Pediatric Clip	S110-280	
		Pediatric Soft	S110S-280	
		Neonate Wrap	S310-280	
		Multi-Site	S810-280	
8604, 8604D		Adult Clip	S410-080	
		Adult Soft	S410S-080	
		Pediatric Clip	S110-080	
		Pediatric Soft	S110S-080	
		Neonate Wrap	S310-080	
		Multi-Site	S810-080	
8000 J-3		Adult Clip	S410-08L0	
		Adult Soft	S410S-08L0	
		Pediatric Clip	S110-08L0	
		Pediatric Soft	S110S-08L0	
		Neonate Wrap	S310-08L0	
		Multi-Site	S810-08L0	

Nonin Short Sensors

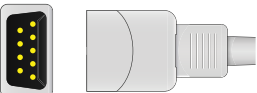
Models	Connector	Options	Part Number	OEM #
2500, 2500A, 2120, 7500, 8500, 8550, 8600, 8700, 8800, 9600, 9700, 9840, Respironics 902M Plus, Lifesense and PureSAT		Adult Clip	S403-080	8000AA, 8000AA-2, 8000AA-3, 01-02-0250, 01-03-0117
		Adult Soft (Large)	S403S-080	8000SL
		Pediatric Clip	S103-080	8000AP, 01-03-0121, 01-02-0106
		Pediatric Soft (Medium)	S103S-080	8000SM
		Infant Soft (Small)	S203S-080	8000SS
		Neonate Wrap	S303-080	
		Multi-Site	S803-080	



Nonin Short Sensors (Continued)

Models	Connector	Options	Part Number	OEM #
Avant 4000 Wearable Digital Pulse Oximetry		Adult Clip	S401-1460	8000AA-WO
		Adult Soft	S401S-1460	8000J-WO

Nonin Disposable Sensors

Models	Connector	Options	Part Number	OEM #
		Adult Box of 24	S503-080	6000CA, 7000A
		Pediatric Box of 24	S523-080	6000CP, 7000P
		Infant Box of 24	S533-080	6000CI, 7000I
		Neonate Box of 24	S543-080	6000CN, 7000N

Nonin Adapter Cables (Also see Nellcor)

Models	Connector	Options	Part Number	OEM #
8604, 8604D	<p>To Monitor:</p>  <p>To Nonin Sensor:</p> 	7 Foot Adapter	E708-080	

Novamatrix Direct Connect Sensors

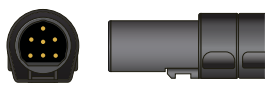
Models	Connector	Options	Part Number	OEM #
505, 510, 511, 515, 515A, 515B, 515C, 520, 520A, 7000, 7100, Oxypleth; Spacelabs: 90351-D/G, 90369, 9046, 90466, 90467, 90489, 90651-07/08, 90419-01, 90651A-07		Adult Clip	S410-030	369083-001, 8776-00
		Adult Soft	S410S-030	
		Pediatric Clip	S110-030	
		Pediatric Soft	S110S-030	
		Neonate Wrap	S310-030	
		Multi-Site	S810-030	8791-00

Novamatrix Short Sensors

Models	Connector	Options	Part Number	OEM #
505, 510, 511, 512, 513, 515B, 515C, 520, 520A, 7000, 7100, Oxypleth; Spacelabs: 90351-D/G, 90465, 90466, 90467, 90489, 90651-07/08, 90419-01, 90651A-07		Adult clip	S403-030	8776-00, 9768-00
		Adult soft	S403S-030	
		Pediatric clip	S103-030	
		Pediatric soft	S103S-030	
		Neonate Wrap	S303-030	9168-00
		Multi-Site	S803-030	9769-00

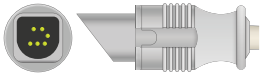
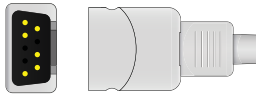

Novametrix Short Sensors (Continued)

Models	Connector	Options	Part Number	OEM #
		Adult clip	S403-1030	8744-00
		Adult soft	S403S-1030	
		Pediatric clip	S103-1030	
		Pediatric soft	S103S-1030	
		Neonate Wrap	S303-1030	
		Multi-Site	S803-1030	8793-00
Respironics 920, 920M, 920M Plus, Tidal Wave 710Sp, 715Sp. Please note that some Respironics 920 models require a 7-pin connector, for these models please request item S403-08T0		Adult clip	S403-730	
		Adult soft	S403S-730	
		Pediatric clip	S103-730	
		Pediatric soft	S103S-730	
		Neonate Wrap	S303-730	
		Multi-Site	S803-730	

Novametrix Disposable Sensors

Models	Connector	Options	Part Number	OEM #
		Adult Box of 24	S503-030	AS110
		Pediatric Box of 24	S523-030	AS120
		Infant Box of 24	S533-030	AS120
		Neonate Box of 24	S543-030	AS140

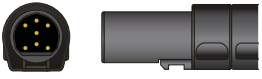
Novametrix Adapter Cables

Models	Connector	Options	Part Number	OEM #
	<p>To Monitor:</p>  <p>To Novametrix Sensor:</p> 	7 Foot Adapter	E708-030	



Pace Tech Direct Connect Sensors

Models	Connector	Options	Part Number	OEM #
Vitalmax 4000, Vitalmax 4100 without touch screen technology (1st version). The SpO2 connector for these Pace Tech monitors are usually identified with a yellow ring around the connector.		Adult Clip	S410-84D0	
		Adult Soft	S410S-84D0	
		Pediatric Clip	S110-84D0	
		Pediatric Soft	S110S-84D0	
		Neonate Wrap	S310-84D0	
		Multi-Site	S810-84D0	

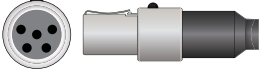
Pace Tech Direct Connect Sensors (Continued)

Models	Connector	Options	Part Number	OEM #
Pace Tech monitors with touch-screen technology such as Vitalmax 4000. The SpO2 connector for these Pace Tech monitors are usually identified with a blue/green ring around the connector.		Adult Clip	S410-66D0	
		Adult Soft	S410S-66D0	
		Pediatric Clip	S110-66D0	
		Pediatric Soft	S110S-66D0	
		Neonate Wrap	S310-66D0	
		Multi-Site	S810-66D0	
Pace Tech Model 520, with black face except for Vitalmax 800w Nellcor		Adult Clip	S410-390	
		Adult Soft	S410S-390	
		Pediatric Clip	S110-390	
		Pediatric Soft	S110S-390	
		Neonate Wrap	S310-390	
		Multi-Site	S810-390	

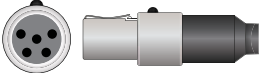
Pace Tech Adapter Cables

Models	Connector	Options	Part Number	OEM #
	<p>To Monitor:</p>  <p>To Nellcor non-Oximax Sensor:</p> 	7 Foot Adapter	E708-390	

Palco Direct Connect Sensors

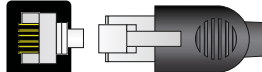
Models	Connector	Options	Part Number	OEM #
		Adult Clip	S410-180	
		Adult Soft	S410S-180	
		Pediatric Clip	S110-180	
		Pediatric Soft	S110S-180	
		Neonate Wrap	S310-180	
		Multi-Site	S810-180	



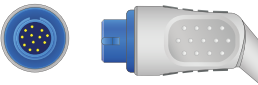
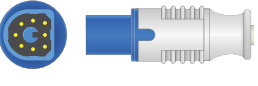
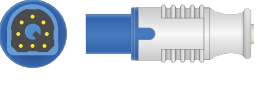



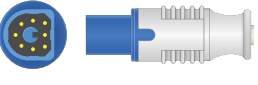

Philips Direct Connect Sensors

Models	Connector	Options	Part Number	OEM #
78352A, 78352C, 78354A, 78354C, 78834C, M1020A, M1025A, M1025B, M1092A, M1094B, M1204A, M1205A, M1350B, M1722A, M1722B, M1190A, M1723A, M1723B, M1732A, M1732B, M2475B, M3046A M4, V24E, Codemaster, HeartStart XL, Agilent 50XM Fetal Monitor		Adult Clip	S410-200	M1190A
		Adult Soft	S410S-200	
		Pediatric Clip	S110-200	
		Pediatric Soft	S110S-200	
		Neonate Wrap	S310-200	
		Multi-Site	S810-200	
C1, C3, M3, M4, MP20, MP30, MP40, MP50, MP60, MP70, MP80, MP90, VM4, VM6, VM8, HP Viridia 24C, Philips HeartStart defibrillator and IntelliVue; Goldway G40; Solaris NT2A, NT2C		Adult Clip	S410-910	M1196A
		Adult Soft	S410S-910	M1191AL, M1191BL
		Pediatric Clip	S110-910	
		Pediatric Soft	S110S-910	
		Neonate Wrap	S310-910	
		Adult Ear Clip	S910-910	
MP20, MP30, MP40, MP50, MP60, MP70, MP90, VN4, VN6, VN8 with Masimo technology		Adult Clip	S410-91M0	
		Adult Soft	S410S-91M0	
		Pediatric Clip	S110-91M0	
		Pediatric Soft	S110S-91M0	
		Neonate Wrap	S310-91M0	
		Multi-Site	S810-91M0	



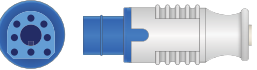

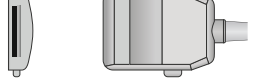

Philips Short Sensors

Models	Connector	Options	Part Number	OEM #
Viridia 24C, C1, C3, M3, M4, MP20, MP30, MP40, MP50, MP60, MP70, MP80, MP90, VM4, VM6, VM8, HeartStart MRx and SureSigns VS3		Adult clip	S403-910	
		Adult soft	S403S-910	M1191A, M1191B, M4531A, 989803109321
		Pediatric clip	S103-910	
		Pediatric soft	S103S-910	M1192A
		Infant soft	S203S-910	M1195A
		Neonate Wrap	S303-910	M1193A
		Adult Ear Clip	S903-910	M1194A
		Multi-Site	S803-910	

Philips Adapter Cables

Models	Connector	Options	Part Number	OEM #
Heartstream XL, IntelliVue MP70, M2601A, M3000A, M3500B, M4735A, M1020B, M3000A/M3001A MMS, M3002A MMS X2, M8102A MP2, M8105A MPS	<p>To Monitor:</p>  <p>To Nellcor non-Oximax Sensor:</p> 	7 Foot Adapter	E708-430	M1943AL, TE1514, 989803128651
	<p>To Monitor:</p>  <p>To Nellcor Oximax Sensor:</p> 	10 Foot Adapter	E710P-430	M1943NL
M2601A, M3000A, M3500 B, M4735A	<p>To Monitor:</p>  <p>To Philips Sensor:</p> 	7 Foot Adapter	E708-410	M1941A, M1941B
	<p>To Monitor:</p>  <p>To Nellcor non-Oximax Sensor:</p> 	7 Foot Adapter	E708-43M0	
Philips IntelliVue FAST-SpO2	<p>To Monitor:</p>  <p>To Masimo LNOP Sensor:</p> 	7 Foot Adapter	E708M-43P0	LNOP MP12, 2282, M1020-61100



Philips Adapter Cables (Continued)

Models	Connector	Options	Part Number	OEM #
SureSigns VS3	<p>To Monitor:</p>  <p>To Masimo LNCS Sensor:</p> 	7 Foot Adapter	E708M-430	LNC MP10, 2281, 9898031 48221
78352C, 78354C, 78834C, M1020A, M1025B, M1205A, M1350, M1722A/B, M1732A/B, M2475B, Viridia A1, Viridia A3	<p>To Monitor:</p>  <p>To Nellcor non-Oximax Sensor:</p> 	7 Foot Adapter	E708-200	M1900A, M1900B
M1020A, M2475B, M1732A/B, M1722A/B, M1020A, 78833C, 78833A, 78834A, 78352C, 78352A	<p>To Monitor:</p>  <p>To Philips Sensor:</p> 	7 Foot Adapter	E708-400	M1940A, M1940B



Physio Control (See Masimo and Nellcor Adapter Cables)

Respironics (See Novamatrix Short Sensors)

Schiller Direct Connect Sensors

Models	Connector	Options	Part Number	OEM #
Argus CM8, SM783, SM784, SM785, TM910		Adult Clip	S410-170	
		Adult Soft	S410S-170	
		Pediatric Clip	S110-170	
		Pediatric Soft	S110S-170	
		Neonate Wrap	S310-170	
		Multi-Site	S810-170	
TM7, Argus Pro, Argus LCM with Masimo technology		Adult Clip	S410-17M0	
		Adult Soft	S410S-17M0	
		Pediatric Clip	S110-17M0	
		Pediatric Soft	S110S-17M0	
		Neonate Wrap	S310-17M0	
		Multi-Site	S810-17M0	

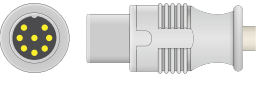
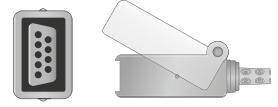
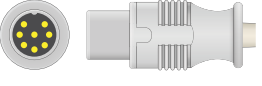
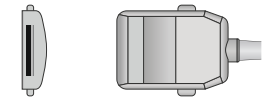
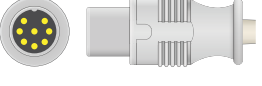
Schiller Adapter Cables

Models	Connector	Options	Part Number	OEM #
Argus TM-7	To Monitor:  To Nellcor non-Oximax Sensor: 	7 Foot Adapter	E708-17M0	
	To Monitor:  To Masimo LNOP Sensor: 	7 Foot Adapter	E708M-17P0	
Also for use as Welch Allyn interface cable	To Monitor:  To Masimo LNCS Sensor: 	7 Foot Adapter	E708M-170	008-0692-02

Siemens (See Drager)

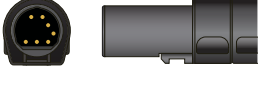
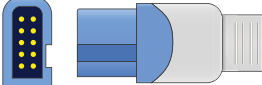

Spacelabs Direct Connect Sensors (Also see Novamatrix)

Models	Connector	Options	Part Number	OEM #
90351-0/6, 90309, 90465, 0466, 90489, 90651-A, IM77, 90308, PC Scout		Adult Clip	S410-040	90651A-08, 015-0130-00, 015-0130-01
		Adult Soft	S410S-040	
		Pediatric Clip	S110-040	
		Pediatric Soft	S110S-040	
		Neonate Wrap	S310-040	
		Multi-Site	S810-040	
1050, 1600, 1700, 90367, 90369, 90469, 90496, Ultraview, 91220, 91369, mCare 300 with Nellcor technology		Adult Clip	S410-740	SP-015-0660-00
		Adult Soft	S410S-740	
		Pediatric Clip	S110-740	
		Pediatric Soft	S110S-740	
		Neonate Wrap	S310-740	
		Multi-Site	S810-740	SP-015-0661-00

Spacelabs Adapter Cables

Models	Connector	Options	Part Number	OEM #
90303B, 90351-0/6, 90465, 0466, 90489, 90651A-08, 90651-A, IM77, 90308, Scout	<p>To Monitor:</p>  <p>To Nellcor non-Oximax Sensor:</p> 	7 Foot Adapter	E708-040	700-0002-00
	<p>To Monitor:</p>  <p>To Nellcor non-Oximax Sensor:</p> 	7 Foot Adapter	E708-740	700-0030-00
1050, 1600, 1700, 90369, 90469, 91220-B, 904, 96, Ultraview and Ultraview SL with Oximax technology	<p>To Monitor:</p>  <p>To Nellcor non-Oximax Sensor:</p> 	10 Foot Adapter	E710-740P0	700-0792-00, 2021
	<p>To Monitor:</p>  <p>To Masimo LNOP Sensor:</p> 	7 Foot Adapter	E708M-740P0	700-0789-00, 700-0789-01
	<p>To Monitor:</p>  <p>To Masimo LNCS Sensor:</p> 	7 Foot Adapter	E708M-740	700-0906-00, 2432 LNC-SL-10

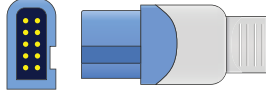

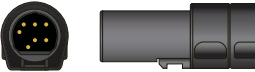
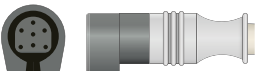
Spacelabs Adapter Cables (Continued)

Models	Connector	Options	Part Number	OEM #
Novametrix 90496, 91496-U	<p>To Monitor:</p>  <p>To Novametrix Sensor:</p> 	1 Foot Adapter	E701-74NV0	700-0029-00
Novametrix 90351D, 90351-G, 90465, 90466, 90467, 90489, 90651-08	<p>To Monitor:</p>  <p>To Novametrix Sensor:</p> 	1 Foot Adapter	E701-04NV0	175-0646-00

Takaoka Direct Connect Sensors

Models	Connector	Options	Part Number	OEM #
9504, 9504 ECG, Oxipani and Oxifast		Adult Clip	S410-990	
		Adult Soft	S410S-990	
		Pediatric Clip	S110-990	
		Pediatric Soft	S110S-990	
		Neonate Wrap	S310-990	
		Multi-Site	S810-990	

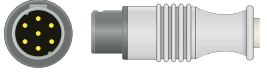
Welch Allyn Adapter Cables (Also See Nellcor and Schiller Adapter Cables)

Models	Connector	Options	Part Number	OEM #
PIC 30, PIC 40 and PIC 50 with Oximax technology	<p>To Monitor:</p>  <p>To Nellcor non-Oximax Sensor:</p> 	4 Foot Adapter	E704P-1040	001966-E

Zoll (See Masimo and Nellcor)

SpO2 Adult Ear Clip

Description	Image	Part Number	OEM #
Attachment for Multi-Sites to apply pulseox sensor on an adult ear lobe.		UEC-010	D-YSE

Vet SpO2 Clip Ear/Tongue Small

Description	Image	Part Number	OEM #
Attachment for Multi-Sites to apply pulseox sensor on small animal (such as dogs, cats) for application on tongue or ear.		UVC-020	

Vet SpO2 Clip Ear/Tongue Large

Description	Image	Part Number	OEM #
Attachment for Multi-Sites to apply pulseox sensor on large animal tongue or ear (lions, bears).		UVC-010	

View full-color photographs of every accessory listed in our catalog. Visit www.CablesandSensors.com and search by part number.



ECG

Compatible patient cables with 3 and 5 leads, snap or clip (grabber)



Choosing your ECG patient cable



3 Leads Snap

Basic trace reading, stronger connection to electrode press stud.



3 Leads Clip (Grabber)

Easy connection to electrode pad without pressing on patient.



5 Leads Snap

Additional traces, press-on snaps provide secure connection reducing false readings.



5 Leads Clip (Grabber)

Additional traces, fast and easy application to electrode pad.

AAMI One Piece ECG Cables

Models	Connector	Options	Part Number	OEM #
All monitor models that require the universal 6-pin round connector		3 Leads Snap	C2340S0	852, 853, 1073/S, 9-10418-02, 8000-0025-02, 9500-0029
		3 Leads Clip	C2340P0	854, 1075/S, 8000-1005-01
		5 Leads Snap	C2540S0	854, 1075/S, 8000-1005-01
		5 Leads Clip	C2540P0	1075/P

Air Shields *(See AAMI and S&W Artema)*

BCI *(See AAMI)*

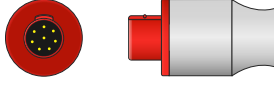

Bionet One Piece ECG Cables

Models	Connector	Options	Part Number	OEM #
BM3		3 Leads Snap	C2314S0	
		3 Leads Clip	C2314P0	
		5 Leads Snap	C2514S0	
		5 Leads Clip	C2514P0	

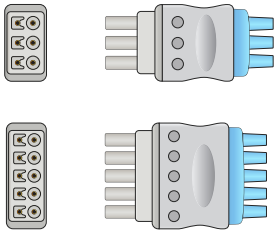
Bionet ECG Leads

Models	Connector	Options	Part Number	OEM #
BM3		3 Leads Snap	LBN3-90S0	
		3 Leads Clip	LBN3-90P0	
		5 Leads Snap	LBN5-90S0	
		5 Leads Clip	LBN5-90P0	

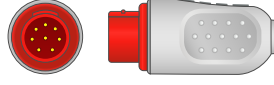
Bionet ECG Trunk Cables

Models	Connector	Options	Part Number	OEM #
BM3	To Monitor: 	3 Leads	TN-23140	
		5 Leads	TN-25140	
	To 3 Leads Set: 			
	To 3 Leads Set: 			



Burdick One Piece ECG Cables (Also see AAMI)

Models	Connector	Options	Part Number	OEM #
CS615, CS625A, CS520, CS523, CS527, CS57200, EK1, EK2, EK3, EK4, EK5/A/AS, EK8SS, M200, Medic 1, Medic 2, Medic 3, Medic 4, Medic 5, PA-100, PA-104, PA-105, 1600, 2100		3 Leads Snap	C2305S0	
		3 Leads Clip	C2305P0	
		5 Leads Snap	C2505S0	
		5 Leads Clip	C2505P0	

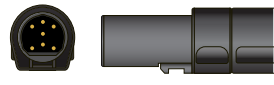
CAS Med One Piece ECG Cables

Models	Connector	Options	Part Number	OEM #
511 Apnea Monitor		3 Leads Snap	C2339S0	
		3 Leads Clip	C2339P0	
CAS Med 750 patient monitor		3 Leads Snap	C2364S0	01-02-0304 + 01-02-0308
		3 Leads Clip	C2364P0	01-02-0304 + 01-02-0350

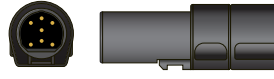
CAS Med ECG Trunk Cables

Models	Connector	Options	Part Number	OEM #
CAS Med 750. For use with DIN-style safety leadwires.	<p>To Monitor:</p>  <p>To 3 Leads DIN Set:</p> 	3 Leads	T-13640	01-02-0304

Colin One Piece ECG Cables (Also see AAMI)

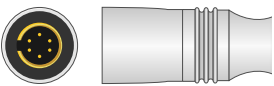
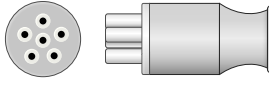
Models	Connector	Options	Part Number	OEM #
BP88 and BP306		3 Leads Snap	C2321S0	
		3 Leads Clip	C2321P0	
BP88S and Colin Press Mate Advantage		3 Leads Snap	C2320S0	MC039-55
		3 Leads Clip	C2320P0	
		5 Leads Snap	C2520S0	
		5 Leads Clip	C2520P0	

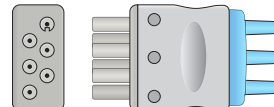

Colin ECG Leads (Also see AAMI)

Models	Connector	Options	Part Number	OEM #
All Colin systems		3 Leads Snap	LCL3-90S0	
		3 Leads Clip	LCL3-90P0	
		5 Leads Snap	LCL5-90S0	
		5 Leads Clip	LCL5-90P0	

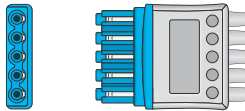
Criticare ECG Leads (Also see AAMI)

Models	Connector	Options	Part Number	OEM #
		3 Leads Snap	LGA3-90S0	1124-A3
		3 Leads Clip	LGA3-90P0	

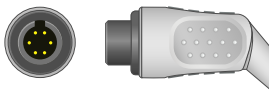
Criticare ECG Trunk Cables (Also see AAMI)

Models	Connector	Options	Part Number	OEM #
	<p>To Monitor:</p>  <p>To 3 Leads Set:</p> 	3 Leads	TGA-25400	1123



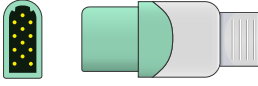
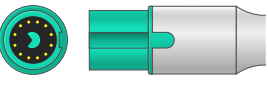

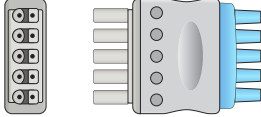
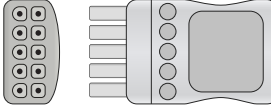

Datascope One Piece ECG Cables

Models	Connector	Options	Part Number	OEM #
Datascope 2000, 2000A, 2001, 2002, 2100, 2200, 3000, 3000A, Ballon Pump, M/D3, M/D3A, M/D4, Passport, Passport IL, Passport EL, Passport XG, Passport XL, Passport 2, Passport 2LT, Passport 5L, Trio, Spectrum, Spectrum OR, System 82, System 83, System 90, System 90T, System 96 and System 97		3 Leads Snap	C2345S0	0131-00-0079, 0012-00-1054-02
		3 Leads Clip	C2345P0	
		5 Leads Snap	C2540S0	
		5 Leads Clip	C2540P0	
Datascope Passport V, V12 and V21		3 Leads Snap	C2326S0	
		3 Leads Clip	C2326P0	
		5 Leads Snap	C2526S0	
		5 Leads Clip	C2526P0	
Mindray Datascope Expert and Fukuda Denshi Dynascope DS-5100, DS-5100E, DS-5300W, DS-5400, DS-7001		3 Leads Snap	C2359S0	
		3 Leads Clip	C2359P0	
		5 Leads Snap	C2559S0	
		5 Leads Clip	C2559P0	

Datascope ECG Leads

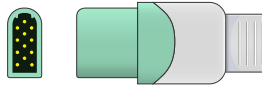
Models	Connector	Options	Part Number	OEM #
Expert, Passport 2, Passport 2LT, Passport XG, Spectrum, Trio; Mindray PM 5000, PM 6000, BeneView T5 and BeneView T8		3 Leads Snap	LR3-90S0	0012-00-1261-07, 0012-00-1261-08, 0012-00-1261-09
		3 Leads Clip	LR3-90P0	0012-00-1262-07, 0012-00-1262-08, 0012-00-1262-09
		5 Leads Snap	LR5-90S0	0012-00-1261-01, 0010-30-42735, 0012-00-1261-02, 0012-00-1261-03
		5 Leads Clip	LR5-90P0	0012-00-1262-01, 0012-00-1262-02, 0012-00-1262-03
Panorama, Panorama Telepack 608, Passport 2, Passport V, Spectrum, Spectrum OR, V12, V21 Mobility leadwires		3 Leads Snap	LDT3-90S0	0012-00-1503-04, 0012-00-1503-05, 0012-00-1503-06
		3 Leads Clip	LDT3-90P0	
		5 Leads Snap	LDT5-90S0	0012-00-1503-01, 0012-00-1503-02, 0012-00-1503-03
		5 Leads Clip	LDT5-90P0	

Datascope ECG Trunk Cables

Models	Connector	Options	Part Number	OEM #
2000, 2001, 2002, 2100, 2200, 3000, 3000A, Balloon Pump, M/D3 with Leads, M/D3A, M/D4, Passport, Passport IL, Passport XG, Passport XL, Passport 2, Passport 2LT, Spectrum System 90, System 90T, System 96, System 97	To Monitor:  To 3 / 5 Leads Set: 	3 / 5 Leads	TR-25400	0012-00-1255-01, 0012-00-1255-02, 0012-00-1255-03, 0012-00-1255-04, 0012-00-1255-05, 0012-00-1255-06
Datascope Passport V, V12, V21. For use with Datascope Mobility Lead Set.	To Monitor:  To 3 / 5 Leads Set: 	3 / 5 Leads	TT-25260	0012-00-1745-01, 0012-00-1745-02
For use with Datascope V-Series / Panorama telemetry leadwires on bedside monitors including Datascope Passport 2, Spectrum and other bedside monitors	To Monitor:  To 3 / 5 Leads Set: 	3 / 5 Leads	TT-25400	0012-00-1502-01

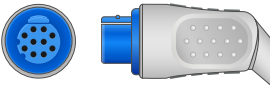

Datex Ohmeda One Piece ECG Cables

Models	Connector	Options	Part Number	OEM #
AS/3, AS/3 Compact, CS/3, S/5, S/5 Compact, Cardiocap 1, Cardiocap 2, Cardiocap 5, Light Monitor, Satellite Plus S/5, Aespire		3 Leads Snap	C2395S0	
		3 Leads Clip	C2395P0	
		5 Leads Snap	C2595S0	
		5 Leads Clip	C2595P0	

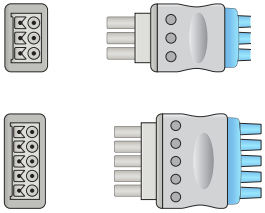
Datex Ohmeda ECG Leads

Models	Connector	Options	Part Number	OEM #
Equipment with ASP connector for Datex Ohmeda, GE, Pro 1000, AS/3, CS/3, Cardiocap II, Cardiocap 5, Satellite Plus S/5		3 Leads Snap	LX3-90S0	545327-HEL, 545315
		3 Leads Clip	LX3-90P0	545317-HEL, 8001958
		5 Leads Snap	LX5-90S0	545328
		5 Leads Clip	LX5-90P0	545318, 545326, 8001959-HEL

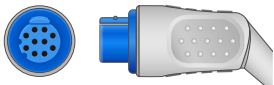

Datex Ohmeda ECG Trunk Cables

Models	Connector	Options	Part Number	OEM #
AS/3, CS/3, S/5, Cardiocap 1, Cardiocap 2, Cardiocap 5, Light Monitor and Satellite Plus S/5	<p>To Monitor:</p>  <p>To 3 Leads Set:</p>  <p>To 5 Leads Set:</p> 	3 Leads	TX-23950	545307, 545302
		5 Leads	TX-25950	545303

DIN Leads ECG Leads

Models	Connector	Options	Part Number	OEM #
Din-Style Safety Leadwires		3 Leads Snap	L3-90S0	0012-00-1255-09, 0012-00-1262-08, 012-0295-00, 012-0283-00, M3915A
		3 Leads Clip	L3-90P0	012-0296, 012-0284-00
		5 Leads Snap	L5-90S0	012-0285-00, 012-0285-01, 012-0605-00
		5 Leads Clip	L5-90P0	012-0286-00, 012-0286-01, 012-0286-02



DIN Leads ECG Trunk Cables

Models	Connector	Options	Part Number	OEM #
DIN Safety Leadwires Trunk Cable	<p>To Monitor:</p>  <p>To 3 Leads Set:</p>  <p>To 5 Leads Set:</p> 	3 Leads	T-23400	0012-00-0991-01, 0012-00-0991-03, 1094/3, 012-0108-01, 012-0201-00
		5 Leads	T-25400	1094/5, 012-0107-01

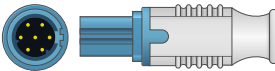
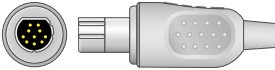

Drager One Piece ECG Cables (Also see Siemens)

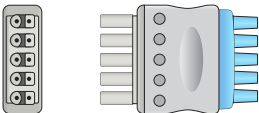
Models	Connector	Options	Part Number	OEM #
SC5000, SC6000, SC7000, SC8000, SC9000		3 Leads Snap 3 Leads Clip	C2323S0 C2323P0	
UM1, UM3, UM3.1, RM1, PM8010, PM8014, Babyguard 8000, Cato, PB8800, PM8060; Series 8000, Cicero, Parameterbox		3 Leads Snap 3 Leads Clip	C2377S0 C2377P0	M35367

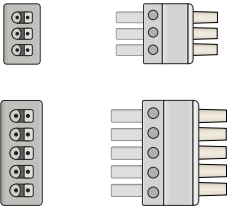
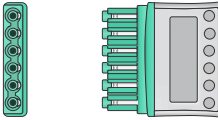

Drager ECG Leads

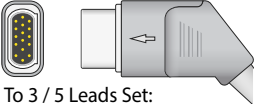
Models	Connector	Options	Part Number	OEM #
For use with MultiMed Pod cable for use with Drager Infinity Vista, Vista, XL, Delta, Delta XL, Gamma, Gamma XL, Gamma X XL, Kappa, Kappa XLT, Siemens 6000, 7000, 9000		3 Leads Snap	LMB3-90S0	5956441
		3 Leads Clip	LMB3-90P0	
		5 Leads Snap	LM5-90S0	
		5 Leads Clip	LM5-90P0	5956458, 5956359
SC5000, SC6000, SC7000, SC8000, SC9000		3 Leads Snap	LM3-90S0	
		3 Leads Clip	LM3-90P0	
Drager PM8060, Vitara, Parameterbox, Julian		3 Leads Clip	LMD3-90RP0	M35361
		5 Leads Clip	LMD5-90RP0	M35363
For use with Drager, MultiMed Plus, MultiMed Plus OR, and to Infinity M300 and Infinity M540 patient monitors		3 Leads Snap	LG3-90S0	
		3 Leads Clip	LG3-90P0	MS16231
		5 Leads Snap	LG5-90S0	
		5 Leads Clip	LG5-90P0	MS16546
		6 Leads Snap	LG6-90S0	
		6 Leads Clip	LG6-90P0	MS16547

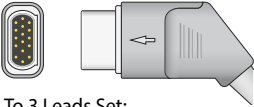
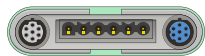
Drager ECG Trunk Cables (Also see Siemens)

Models	Connector	Options	Part Number	OEM #
For use with MultiMed Pod for Drager Infinity Vista, Vista XL, Delta, Delta XL, Gamma, Gamma XL, Gamma X XL, Kappa, Kappa XLT and Siemens 6000, 7000, 9000	To Monitor:  To 3 / 5 Leads Set: 	5 Leads, 2.5m	TM-STE50	3368391, 5950196
MultiMed® Plus Pod for 3, 5 or 6 leads, respiration, one temperature and SpO2 for use with the following monitors: Draeger Infinity Vista, Vista XL, Delta, Delta XL, Gamma, Gamma XL, Gamma X XL, Kappa, and Kappa XL	To Monitor:  To 3 Leads Set: 	3, 5, 6 Leads	TG-STE60	MS20093

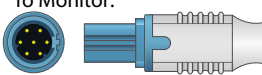

Drager ECG Trunk Cables (Continued)

Models	Connector	Options	Part Number	OEM #
SC5000, SC6000, SC7000, SC8000, SC9000	To Monitor:  To 3 Leads Set: 	3 Leads	TM-23230	

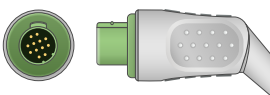
Fukuda Denshi One Piece ECG Cables (Also see Datascope and Drager)

Models	Connector	Options	Part Number	OEM #
		5 Leads Snap	C2599S0	
		5 Leads Clip	C2599P0	
		10 Leads Snap	C21099S0	
		10 Leads Clip	C21099P0	

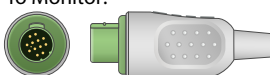
Fukuda Denshi ECG Trunk Cables (Also see Datascope and Drager)

Models	Connector	Options	Part Number	OEM #
	To Monitor:  To 5 Leads Set:  To 10 Leads Set: 	5 Leads	TM-25990	
		10 Leads	TQ-210990	



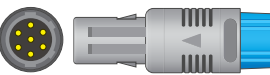

GE Ultrasound One Piece ECG Cables

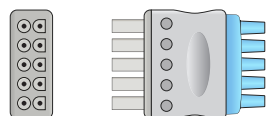
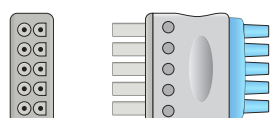
Models	Connector	Options	Part Number	OEM #
GE Vivid i, Vivid q Ultrasound		3 Leads Snap	C2382S0	
		3 Leads Clip	C2382P0	2418831-2

GE Ultrasound ECG Leads

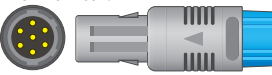
Models	Connector	Options	Part Number	OEM #
GE Vivid i, Vivid q ultrasound systems		3 Leads Snap	LQA3-90S0	
		3 Leads Clip	LQA3-90P0	S2424557
GE Logiq P6 and P6 Pro ultrasound systems		3 Leads Snap	LQB3-90S0	
		3 Leads	LQB3-90P0	

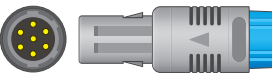
GE Ultrasound ECG Trunk Cables



Models	Connector	Options	Part Number	OEM #
GE Vivid i, Vivid q Ultrasound	<p>To Monitor:</p>  <p>To 3 Leads Set:</p> 	3 Leads	TQA-23820	52424549
GE Logiq P6 and P6 Pro ultrasound systems	<p>To Monitor:</p>  <p>To 3 Leads Set:</p> 	3 Leads	TQB-23810	5341189

Goldway (See Mindray)

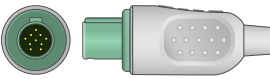
Hellige One Piece ECG Cables

Models	Connector	Options	Part Number	OEM #
Servomed 4, Generation, SCP 851, SCP 852, SCP 852, SCP 844, SCS 804, CardioServ, VICOM-sm		3 Leads Snap	C2355S0	303-442-99
		3 Leads Clip	C2355P0	
		5 Leads Snap	C2555S0	
		5 Leads Clip	C2555P0	

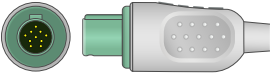
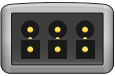
Hellige ECG Trunk Cables

Models	Connector	Options	Part Number	OEM #
Hellige, Servomed 4, Generation, SCP 851, SCP 852, SCP 844, SCS 804, CardioServ, VICOM-sm. For use with Datex Ohmeda leadwires series LX3-9050.	<p>To Monitor:</p>  <p>To 3 Leads Set:</p>  <p>To 5 Leads Set:</p> 	3 Leads	TX-23550	
		5 Leads	TX-25550	

Infinium One Piece ECG Cables

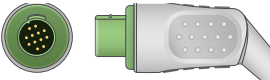
Models	Connector	Options	Part Number	OEM #
Infinium Mira, Vega; Kontron: 7000, 7135, 7135B, 7141, 7210, 7250, 7251, K2000, KAAT, Kolormon, Micromon, Minimon, Supermon, Vitalmon; Larsen & Toubro (L&T Medical) Stellar P, Star 50, Galaxy, Planet, Planet 50, Cosmic		3 Leads Snap	C2398S0	
		3 Leads Clip	C2398P0	

Infinium ECG Trunk Cables

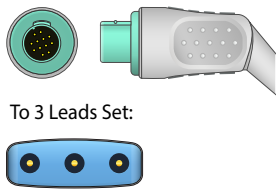
Models	Connector	Options	Part Number	OEM #
Mira, Vega; Kontron: 7000, 7135, 7135B, 7141, 7210, 7250, 7251, K2000, KAAT, Kolomon, Micromon, Minimon, Supermon, Vitalmon; Larsen & Toubro (L&T Medical) Stellar P, Star 50, Galaxy, Planet, Planet 50, Cosmic. For use with the DIN-Style Safety Leadwires.	<p>To Monitor:</p>  <p>To 3 Leads Set:</p>	3 Leads	T-13980	

Invivo (See AAMI)

Kontron (See Infinium)

LL Style ECG Leads

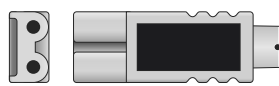
Models	Connector	Options	Part Number	OEM #
LL-style connector leads		3 Leads Snap	LLL3-90S0	
		3 Leads Clip	LLL3-90P0	
		5 Leads Snap	LLL5-90S0	
		5 Leads Clip	LLL5-90P0	

LL Style ECG Trunk Cables

Models	Connector	Options	Part Number	OEM #
	<p>To Monitor:</p>  <p>To 3 Leads Set:</p>	3 Leads	TL-13400	
		5 Leads	TL-15400	

Lohmeier One Piece ECG Cables

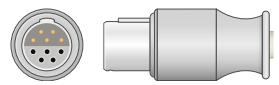
Models	Connector	Options	Part Number	OEM #
M010, M011, M211 and 501 Defibrillator		3 Leads Snap	C2358S0	
		3 Leads Clip	C2358P0	



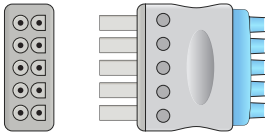
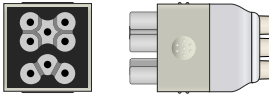
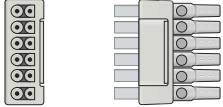

Marquette (GE) One Piece ECG Cables

Models	Connector	Options	Part Number	OEM #
Dash 1000, Dash PRO 2000, Dash 2500, Dash PRO 3000, Dash PRO 4000, Dash 5000, Eagle Systems, MAC-Lab, Solar 3000, Solar 8000, Solar 9500, Aestiva/5, Tram 100, Tram 200, Tram 300, Tram 400, Tram 500, Tram 600, Tram 800, Responder 2000, Responder 3000, Corometrics 120, GE Vivid 7 Ultrasound, Datex Ohmeda E Prestin modules and Unity Systems		3 Leads Snap	C2386S0	2021141-001
		3 Leads Clip	C2386P0	2021141-001
		5 Leads Snap	C2586S0	
		5 Leads Clip	C2586P0	

Marquette (GE) ECG Leads

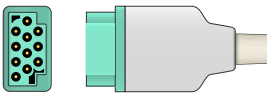
Models	Connector	Options	Part Number	OEM #
		3 Leads Snap	LQ3-90S0	416467-004, 411202-001, 411203-001
		3 Leads Clip	LQ3-90P0	412682-001, 412682-002
		5 Leads Snap	LQ5-90S0	411202-001, 411200-001
		5 Leads Clip	LQ5-90P0	414556-001, 414556-002, 412681-001, 412681-002, 412681-005, 414556-001, 414556-002, 414556-003, E9002ZW
		5 Leads V2-V6 Snap	LV5-90S0	416468-001, 416468-003
		5 Leads V2-V6 Clip	LV5-90P0	416467-001, 416467-003
GE ApexPro FH Telemetry System		3 Leads Snap	LAP3-90S0	
		3 Leads Clip	LAP3-90P0	
		5 Leads Snap	LAP5-90S0	394111-012, 394111-006
		5 Leads Clip	LAP5-90P0	394111-005, 394111-011
		6 Leads Snap	LAP6-90S0	
		6 Leads Clip	LAP6-90P0	
GE ApexPro CH Telemetry System		6 Leads Snap	LQB6-90S0	421930-001, 421930-002, 421930-003
		6 Leads Clip	LQB6-90P0	421932-001, 421932-002, 421932-003

Marquette (GE) ECG Trunk Cables

Models	Connector	Options	Part Number	OEM #
Dash 1000, Dash Pro 2000, Dash 2500, Dash Pro 3000, Dash Pro 4000, Dash 5000, Eagle Systems, MAC-Lab, Solar 3000, Solar 8000, Solar 9500, Aestiva/5, Tram 100, Tram 200, Tram 300, Tram 400, Tram 500, Tram 600, Tram 800, Unity Systems and Carescape	<p>To Monitor:</p>  <p>To 3 / 5 Leads Set:</p> 	5 Leads	TQ-25860	2017003-001, 2017003-002, 2017003-003, 2017004-001, 412681-005, 412931-001, E9002ZB
For use with safety DIN leadwires	<p>To Monitor:</p>  <p>To 3 Leads DIN Set:</p>  <p>To 5 Leads DIN Set:</p> 	3 Leads	T-13860	CB-713006R
		5 Leads	T-15860	CB-715006

Medtronic One Piece ECG Cables

Models	Connector	Options	Part Number	OEM #
Lifepak 11, Lifepak 12, Lifepak 15, Lifepak 20, Lifepak 20E		3 Leads Snap	C2327S0	11110-000029, 3006218-02
		3 Leads Clip	C2327P0	
		5 Leads Snap	C2527S0	11110-000066
		5 Leads Clip	C2527P0	

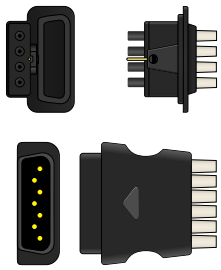

Medtronic ECG Leads

Models	Connector	Options	Part Number	OEM #
Lifepak 11, Lifepak 12, Lifepak 15 and Lifepak 20, Lifepak 20E		4 Leads Snap	LDA4-120S0	11110-000102, 805265-03
		4 Leads Clip	LDA4-120P0	
		6 Leads Snap	LDB6-90S0	11110-000103, 805265-04
		6 Leads Clip	LDB6-90P0	

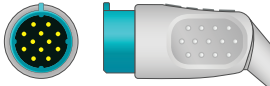
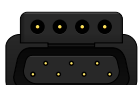
Medtronic ECG Trunk Cables

Models	Connector	Options	Part Number	OEM #
Lifepak 11, Lifepak 12, Lifepak 15, Lifepak 20, Lifepak 20E	<p>To Monitor:</p>  <p>To 4 / 6 Leads Set:</p> 	10 Leads	TD-210270	11110-000110, 11110-000111, 805265-23

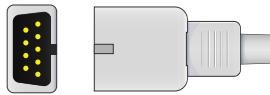
MEK One Piece ECG Cables

Models	Connector	Options	Part Number	OEM #
MP1000, MP600, MP500		3 Leads Snap	C2310S0	
		3 Leads Clip	C2310P0	
		5 Leads Snap	C2510S0	
		5 Leads Clip	C2510P0	
M160246 and 360697; Votem VP-700, VP-1000; VP-1200		3 Leads Snap	C2311S0	
		3 Leads Clip	C2311P0	
		5 Leads Snap	C2511S0	
		5 Leads Clip	C2511P0	

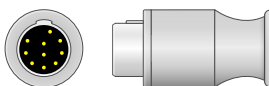
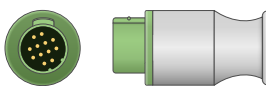

Mennen One Piece ECG Cables

Models	Connector	Options	Part Number	OEM #
900, 1100, 1110, Horizon 2000, 2100, 2200, 5200, Horizon 9000XL, MR1200, 1270, 1280, 1300, 1380		3 Leads Snap	C2374S0	
		3 Leads Clip	C2374P0	
		5 Leads Snap	C2574S0	
		5 Leads Clip	C2574P0	
Envoy, Enmove 1000		3 Leads Snap	C2375S0	
		3 Leads Clip	C2375P0	
		5 Leads Snap	C2575S0	
		5 Leads Clip	C2575P0	

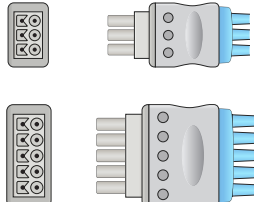
Mennen ECG Leads

Models	Connector	Options	Part Number	OEM #
Mennen Envoy and Schiller Argus LCM		3 Leads Snap	LMN3-90S0	
		3 Leads Clip	LMN3-90P0	
		5 Leads Snap	LMN5-90S0	
		5 Leads Clip	LMN5-90P0	

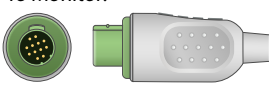
Mennen ECG Trunk Cables

Models	Connector	Options	Part Number	OEM #
Envoy, Enmove 1000	<p>To Monitor:</p>  <p>To 3 Leads Set:</p>  <p>To 5 Leads Set:</p> 	3 Leads	TA-23750	
		5 Leads	TA-25750	

Mindray One Piece ECG Cables (Also see Datascope)

Models	Connector	Options	Part Number	OEM #
Mindray: PM9000, PM8000, PM7000 with a 6-pin connector; Goldway: UT4000A, UT4000A, UT4000Apro, UT6000A, UT4000B, UT4000C, UT4000F, UT6000F, UT4000Fpro, UT4800, Goldway G40		3 Leads Snap	C2340S0	
		3 Leads Clip	C2340P0	
		5 Leads Snap	C2540S0	
		5 Leads Clip	C2540P0	

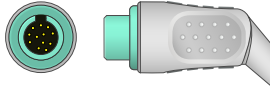

Mindray One Piece ECG Cables (Continued)

Models	Connector	Options	Part Number	OEM #
MEC 1000, PM5000, PM6000 with a 12-pin connector, BeneView T5, T8, DPM6, DPM7 and iPM-9800. Also compatible for Penlon Intermed patient monitors		3 Leads Snap	C2312S0	0010-30-42719
		3 Leads Clip	C2312P0	
		5 Leads Snap	C2512S0	
		5 Leads Clip	C2512P0	

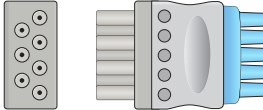
Mindray ECG Leads (Also see Datascope)

Models	Connector	Options	Part Number	OEM #
Mindray TMS-6016 and Tel-100 Telemetry System. Also for use with Mortara and Mennen Telemetry Systems		3 Leads Snap	LTM3-90S0	115-004867-00
		3 Leads Clip	LTM3-90P0	115-004871-00
		5 Leads Snap	LTM5-90S0	115-004869-00
		5 Leads Clip	LTM5-90P0	115-004873-00

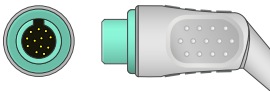
Mindray ECG Trunk Cables (Also see Datascope)

Models	Connector	Options	Part Number	OEM #
PM5000, PM6000, T5 and T8	To Monitor:  To 3 / 5 Leads Set: 	3 / 5 Leads	TR-25120	0010-30-42719

NEC ECG Leads

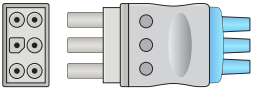
Models	Connector	Options	Part Number	OEM #
All NEC systems		3 Leads Snap	LECA3-90S0	
		3 Leads Clip	LECA3-90P0	

Nihon Kohden One Piece ECG Cables (Also see AAMI)

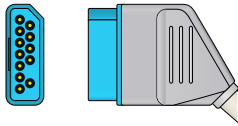
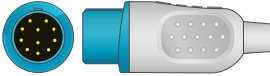
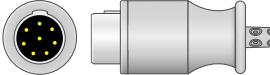
Models	Connector	Options	Part Number	OEM #
BSM-2300 Life Scope I, BSM-2301A, BSM-2301K, BSM-2351A, BSM-4100, BSM-4102, BSM-4102A, Life Scope P, BSM-5100 Life Scope A, Life Scope TR, BSM-6000 series, BSM-6301K, BSM-6501K, BSM-6701K, Life Scope J, BSM-9101, PVM-2701, BSM-9510 Life Scope M, BSM-9500 Life Scope S		3 Leads Snap	C2309S0	
		3 Leads Clip	C2309P0	
OEC-6102A (s/n<20156), OEC-6105A (s/n<20226), OEC-6120A/J/K, TEC-7621C, TEC-7631C, TEC-7721C, TEC-7731C, TEC-7731K, TEC-7700, Cardiolife Bifasic Defibrillator		3 Leads Snap	C2313S0	BC-753V
		3 Leads Clip	C2313P0	
Merlin 78352C, Merlin 78354C, Merlin 78834C, M1001A, M1002A, Viridia, Omnicare CMA, ML65A, 66A, Heartstream and Codemaster XL		3 Leads Snap	C23029S0	
		3 Leads Clip	C23029P0	
		5 Leads Snap	C25029S0	
		5 Leads Clip	C25029P0	



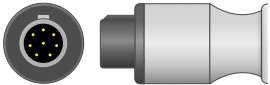
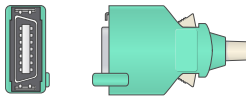

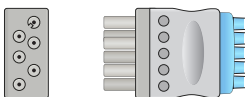
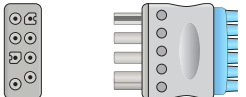

Nihon Kohden One Piece ECG Cables (Continued)

Models	Connector	Options	Part Number	OEM #
OEC-6102A (s/n<20156), OEC-6105A (s/n<20226), OEC-6120A/J/K		3 Leads Snap	C2308S0	
		3 Leads Clip	C2308P0	
		5 Leads Snap	C2508S0	
		5 Leads Clip	C2508P0	
Life Scope OPV-1500, Life Scope N OPV-1500K		3 Leads Snap	C2316S0	
		3 Leads Clip	C2316P0	

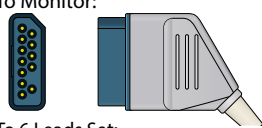
Nihon Kohden ECG Leads (Also see AAMI and Spacelabs)

Models	Connector	Options	Part Number	OEM #
Cardiolife, Life Scope series 6, 8, 9, 11, 6102, 6205, 6120		3 Leads Snap	LKA3-90S0	
		3 Leads Clip	LKA3-90P0	
		5 Leads Snap	LKA5-90S0	
		5 Leads Clip	LKA5-90P0	
BSM-2300 Life Scope I, BSM-2301, BSM-4100 Life Scope P, BSM-5100 Life Scope A, Life Scope TR, BSM-6000 series, BSM-6301K, BSM-6501K, BSM-6701K, BSM-9510 Life Scope M, BSM-9800 Life Scope S, ZM-900 Series Transmitters, Life Scope 6700 Series		3 Leads Snap	LKB3-90S0	BR-913P K910A, BR-913PA K910B
		3 Leads Clip	LKB3-90P0	BR-903P K911, BR-903PA K911A
		6 Leads Snap	LKB6-90S0	BR-916P K915, BR-916PA K915A
		6 Leads Clip	LKB6-90P0	BR-906P K912, BR-916PA K915A

Nihon Kohden ECG Trunk Cables (Also see AAMI and Spacelabs)

Models	Connector	Options	Part Number	OEM #
BSM-2300 Life Scope I, BSM-2301, BSM-2351A, BSM-4100 Life Scope P, BSM-4102, BSM-4102A, BSM-5100 Life Scope A, Life Scope TR, BSM-6000 series, BSM-6301K, BSM-6501K, BSM-6701K, Life Scope J, BSM-9101, PVM-2701, BSM-9510 Life Scope M, BSM-9800 Life Scope S, Life Scope 6700 Series	To Monitor:  To 6 Leads Set: 	6 Leads	TK-25090	JC-906P
OEC-6102A (s/n<20156), OEC-6105A (s/n<20226), OEC-6120A/J/K, TEC-7100K	To Monitor:  To 3 / 5 Leads Set: 	3 / 5 Leads	TK-25080	
BSM-7102A, OMP-7201C, OMP-7203C, TEC-5200A (s/n<20421)	To Monitor:  To 3 / 5 Leads Set: 	3 / 5 Leads	TK-25070	

Palco (See AAMI)

Penlon (See Mindray)

Petas One Piece ECG Cables

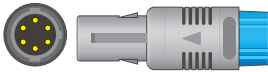
Models	Connector	Options	Part Number	OEM #
KMA160R, 165R, 260R, K-250, 300		4 Leads Snap	C24026S0	
		4 Leads Clip	C24026P0	

Philips One Piece ECG Cables (Also see AAMI)

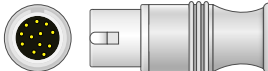
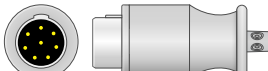
Models	Connector	Options	Part Number	OEM #
Philips HeartStart defibrillator, Philips Agilent, Envisor, IntelliVue, MP 20, MP 30, MP 50, IE33, Philips HeartStart defibrillator, Philips Agilent, IntelliVue, IE33, 43100A, 43110A, 43120A, 78352C, 78354C, 78834C, 862474 C3, M1001A, M1002A, M1165A, M1166A, M1167A, M1175A, M1177A, M1204A, M1205A, M1264A, M1275A Transport, M1280A, M1722A/B, M1723A/B, M2475B, M2601A, M3000A, M3001A, M3046A, M2, M3, M4, M4735A, V24E, Agilent 50XM Fetal Monitor; Newtech NT3A; Solaris NT3A, NT3B, NT3C, NT3E, NT3F		3 Leads Snap	C2385S0	M1972A, 2017003-001
		3 Leads Clip	C2385P0	M1981A
		5 Leads Snap	C2585S0	M1977A
		5 Leads Clip	C2585P0	M1986A
Codemaster XL, Codemaster 100, 43100A, 43110A, 43110M, 43120A, MC Defibrillator, 43200A Portable, M3500B, 77000AC, 77020A, 77010AC, Sonos/AC/AR, 77025A, 77030A, 77035A, 77040A, 78208A, 78210A, 78330A, 7833 1A, 78332A, 78333A, 78341A, 78342A, 78345A, 78346A, 78351T, 78352A/C, 78353A/B, 78354A, 78532A/B, 78534A/B/C, 78619A, 78620A, 78660A/B, 78661A/B, 78670A, 78671A, M1722A/B, M1723A/B, M2400A, M2406A, Sonos 2000/2500, tems, M2425A, M2475B		3 Leads Snap	C23029S0	M1735A
		3 Leads Clip	C23029P0	
		5 Leads Snap	C25029S0	M1736A
		5 Leads Clip	C25029P0	



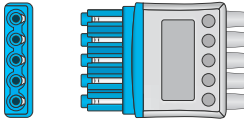
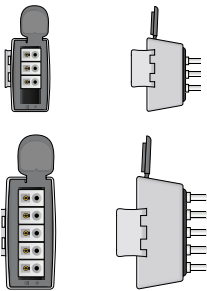



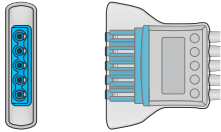
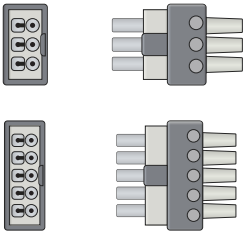

Philips ECG Leads (Also see AAMI)

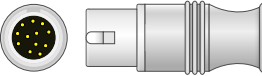
Models	Connector	Options	Part Number	OEM #
For use with Philips M1668A ECG trunk cable		3 Leads Snap	LP3-90S0	M1673A
		3 Leads Clip	LP3-90P0	M1671A, M1675A
		5 Leads Snap Limbs	LPA5-90S0	M1644A, 989803144991
		5 Leads Clip Limbs	LPA5-90P0	M1968A, 989803125841
		5 Leads Snap Chest V2-V6	LPB5-90S0	M1602A
		5 Leads Clip Chest V2-V6	LPB5-90P0	M1976A
M2601A, M2600A and M2636A Viridia M2600A Telemetry System		3 Leads Snap	LAT3-90S0	M2590A, 989803106311
		3 Leads Clip	LAT3-90P0	M2591A
		5 Leads Snap	LAT5-90S0	M2592A, 989803106331
		5 Leads Clip	LAT5-90P0	M2593A, 989803106341

Philips ECG Leads (Continued)

Models	Connector	Options	Part Number	OEM #
IntelliVue 862108, M4840A, M2600B, M2601B Viridia Telemetry		5 Leads Snap	LHT5-90SO	989803152071, 989803133871, 989803137241
		5 Leads Clip	LHT5-90PO	989803152051, 989803133881, 989803137251
For use with Philips M1500A trunk cable		3 Leads Snap	LAB3-90SO	M1605A, M1633A, M1626A, M2592A, M1613A, 0012-00-0847
		3 Leads Clip	LAB3-90PO	M1603A, M1608A, 989803104371, 989803104401, M1609A, 989803104411
		5 Leads Snap	LAB5-90SO	M1625A, 0012-00-1003-01
		5 Leads Clip	LAB5-90PO	M1623A, M1621A, M1629A, 989803104541

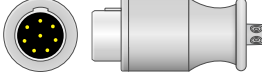
Philips ECG Trunk Cables

Models	Connector	Options	Part Number	OEM #
78352C, 78354C, 78834C, Legacy HP Patient Monitors 862472 to 862475, C3 Monitor 862478, 862479 C3 Monitor 863064, 863065, 863066, 863068, SureSigns VM6, VM8, ECG Modules M1001A/B, M1002A/B, Multi-Measurement Modules M3000A, M3001A, M3002A MMS X2, M8102A MP2 Monitor, M8105A MP5 Monitor, M4735A, HeartStart XL, Defibrillator Monitor M3535A, M3536A, HeartStart MRx Defibrillator. For use with the Philips M1644A (LPA5-90S0) Lead Set	<p>To Monitor:</p>  <p>To 3 Leads Set:</p>  <p>To 5 Leads Set:</p> 	3 Leads	TP-23850	M1669A, 989803145071
		5 Leads	TP-25850	M1668A, 989803145061
Merlin, Viridia, Omnicare CMA, Heartstream, Envisor, IntelliVue, V24/V26, IE33, C Series Monitors, 78352C, 78354A/C, 78834A/B/C, M1001A, M1001B, M1002A, M1002B, M1722A, M1722B, M1723A, M1723B, M2475B, M3000A, M3001A, M4735A. For use with the Philips M1605A (LAB3-90S0) Lead Set	<p>To Monitor:</p>  <p>To 3 Leads Set:</p>  <p>To 5 Leads Set:</p> 	3 Leads	TA-23850	M1500A, M1510A, M1540C, 0012-00-0846, 4535-612-33921
		5 Leads	TA-25850	M1520A, M1560C, 0012-00-1002-01
Codemaster XL, 782xxA Series, 783xxA Series, 785xxA/B/C Series, 786xxA/B Series, 77000AC, 77020A/AC, 77020AR, 77025A, 77030A, 77035A, 77040A, 78208A, 78210A, 78330A, 78331A, 78332A, 78333A, 78341A, 78342A, 78345A, 78346A, 78351T, 78352A, 78353A/B, 78354A, 78532A/B, 78534A/B/C, M1722A/B, M1723A/B, M2400A, M2406A, M2475B, M3500B and 43011A Defibrillator. For use with the Philips M1605A (LAB3-90S0) Lead Set	<p>To Monitor:</p>  <p>To 3 Leads Set:</p>  <p>To 5 Leads Set:</p> 	3 Leads	TA-230290	M1580A
		5 Leads	TA-250290	M1600A

Physio Control (See AAMI and Medtronic)

Primedic One Piece ECG Cables

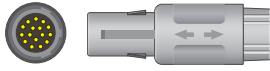
Models	Connector	Options	Part Number	OEM #
Primedic Defi-Monitor DM 10, DM 30		4 Leads IEC Clip	C2415P-10	

Schiller One Piece ECG Cables

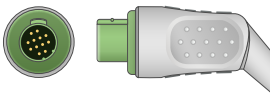
Models	Connector	Options	Part Number	OEM #
Defigard 4000 defibrillator		3 Leads Snap	C2354S0	
		3 Leads Clip	C2354P0	

Siemens One Piece ECG Cables (Also see AAMI and Drager)

Models	Connector	Options	Part Number	OEM #
Sirecust Series 400, 500, 600, 700, 900, 1200, Sirecust 341, 610, 620, 630, 720, 722, 730, 732, 900, 960, 961, 1260, 1281, 1801, 400, 500 ECG Monitor, Modulo Polymed y Modulbox Sirem		3 Leads Snap	C2376S0	
		3 Leads Clip	C2376P0	
		5 Leads Snap	C2576S0	
		5 Leads Clip	C2576P0	

Siemens ECG Trunk Cables (Also see AAMI and Drager)

Models	Connector	Options	Part Number	OEM #
Sirecust Series 400, 500, 600, 700, 900, 1200, Sirecust 341/610/620/ 630/720/722, Sirecust 730/732/900/960/961/ 1260, Sirecust 1281/ 1801/400/500, ECG Monitor, Modulo Polymed, Modulbox Sirem		3 Leads	TM-23760	
		5 Leads	TM-25760	

Spacelabs One Piece ECG Cables (Also see AAMI)

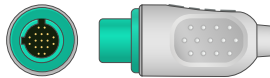
Models	Connector	Options	Part Number	OEM #
True-Link Cable for 90309, 90496 Ultraview, 90369 Ultraview, 90367 Ultraview, 91220 mCare 300, 91369 Ultraview SL and Elance Series		3 Leads Snap	C2396S0	700-0008-08, 72713
		3 Leads Clip	C2396P0	
		5 Leads Snap	C2596S0	700-0008-06, 72715
		5 Leads Clip	C2596P0	



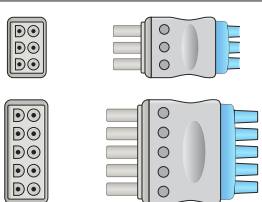

Spacelabs ECG Leads (Also see AAMI and DIN Leads)

Models	Connector	Options	Part Number	OEM #
90492, 91220, 90496, 91496		3 Leads Snap	LLB3-90S0	012-0498, 700-0007-00, 700-0007-02
		3 Leads Clip	LLB3-90P0	700-0006-00, 700-0006-02
		5 Leads Snap	LLB5-90S0	700-0007-08, 700-0007-10
		5 Leads Clip	LLB5-90P0	700-0006-08, 700-0006-10

Spacelabs ECG Leads (Continued) *(Also see AAMI and DIN Leads)*

Models	Connector	Options	Part Number	OEM #
		3 Leads Snap	LSL3-9050	
		3 Leads Clip	LSL3-90P0	
		5 Leads Snap	LSL5-9050	
		5 Leads Clip	LSL5-90P0	

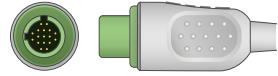
Spacelabs ECG Trunk Cables *(Also see AAMI)*

Models	Connector	Options	Part Number	OEM #
90492, 90496 Ultraview, 90369 Ultraview, 90367 Ultraview, 91496, Elance Series	To Monitor:  To 3 Leads Set:  To 5 Leads Set: 	3 Leads	TL-23960	012-0108-01, 7271
		5 Leads	TL-25960	700-0008-06, 7271
For use with safety DIN leadwires	To Monitor:  To 3 Leads DIN Set:  To 5 Leads DIN Set: 	3 Leads	T-13960	700-0008-10, 700-0008-11
		5 Leads	T-15960	

S&W Artema One Piece ECG Cables

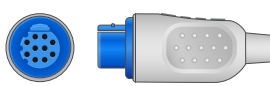
Models	Connector	Options	Part Number	OEM #
S&W Artema: 8000, Diascope 1, Diascope 2, Diascope NT, Athena, Cardio Aid 200; Air Shields monitors		3 Leads Snap	C239750	
		3 Leads Clip	C2397P0	

Welch Allyn One Piece ECG Cables

Models	Connector	Options	Part Number	OEM #
Propaq 100 Series, Propaq 200 Series, Propaq Encore, Propaq CS, Ultra Smart, Atlas, PIC 30, PIC 40 and PIC 50		3 Leads Snap	C234050	
		3 Leads Clip	C2340P0	
		5 Leads Snap	C254050	
		5 Leads Clip	C2540P0	

Zoll *(See AAMI)*



Disposable ECG

Single-use leadwires and one-piece cables reduce cross-contamination from healthcare-associated infections

Disposable Leadwires
36 inch leadwires



One Piece Disposable
11 foot cable



Leadwire Adapters
Connect to any trunk cable



Datascope Disposable One Piece ECG Cable

Models	Connector	Options	Part Number	OEM #	Packaging
KMA160R, 165R, 260R, K-250, 300		5 Leads Grabber	C2540DP0		Case of 10

Datascope Disposable ECG Leadwires

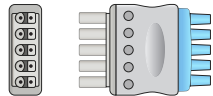
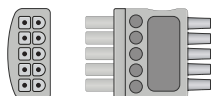
Models	Connector	Options	Part Number	OEM #	Packaging
Datascope, Mindray bedside monitors		3 Leads Grabber	LR3-90DP0		Case of 10
		5 Leads Grabber	LR5-90DP0		Case of 10
Datascope Mobility leadwires		3 Leads Grabber	LDT3-90DP0		Case of 10
		5 Leads Grabber	LDT5-90DP0		Case of 10

DIN-Style Safety Disposable ECG Leadwires

Models	Connector	Options	Part Number	OEM #	Packaging
		3 Leads Grabber	L3-90DP0		Case of 10
		5 Leads Grabber	L5-90DP0		Case of 10

Marquette Disposable One Piece ECG Cable

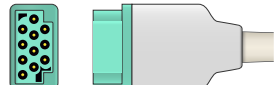
Models	Connector	Options	Part Number	OEM #	Packaging
KMA160R, 165R, 260R, K-250, 300		5 Leads Grabber	C2586DP0		Case of 10

Marquette Disposable ECG Leadwires

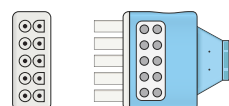
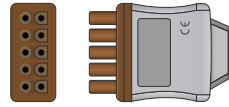
Models	Connector	Options	Part Number	OEM #	Packaging
GE Multi-Link trunk cables		3 Leads Grabber	LQ3-90DP0		Case of 10
		5 Leads Grabber	LQ5-90DP0	Covidien: 33112	Case of 10
GE Multi-Link V2 - V6 leads		5 Leads Grabber	LV5-90DP0		Case of 10

Nihon Kohden Disposable ECG Leadwires

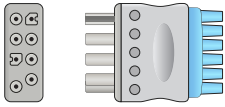
Models	Connector	Options	Part Number	OEM #	Packaging
		3 Leads Grabber	LKB3-90DP0		Case of 10
		6 Leads Grabber	LKB6-90DP0	Covidien: 33134	Case of 10

Philips Disposable One Piece ECG Cable

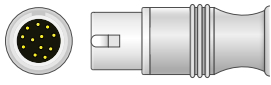
Models	Connector	Options	Part Number	OEM #	Packaging
Philips IntelliVue bedside monitors		5 Leads Grabber	C2585DP0		Case of 10

Philips Disposable ECG Leadwires

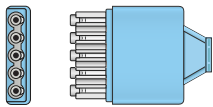
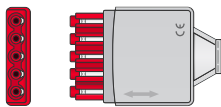
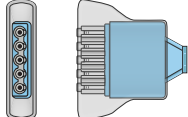
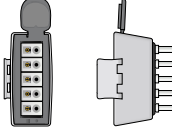
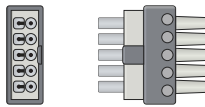
Models	Connector	Options	Part Number	OEM #	Packaging
Philips IntelliVue bedside monitors		3 Leads Grabber	LPA3-90DP0	989803173121	Case of 10
		5 Leads Grabber	LPA5-90DP0	Philips: 989803173131; Covidien 33114	Case of 10
Philips IntelliVue V2 - V6 leads		5 Leads Grabber	LPB5-90DP0		Case of 10
Philips IntelliVue M2601B telemetry		3 Leads Grabber	LHT3-90DP0	989803173141	Case of 10
		5 Leads Grabber	LHT5-90DP0	Philips: 989803173151	Case of 10
Philips M2601A telemetry		3 Leads Grabber	LAT3-90DP0		Case of 10
		5 Leads Grabber	LAT5-90DP0	Covidien: 33113	Case of 10
Philips Twin Pin (AA style) for use with Philips M1500 Series bedside trunk cables		3 Leads Grabber	LAB3-90DP0		Case of 10
		5 Leads Grabber	LAB5-90DP0		Case of 10

Spacelabs Disposable One Piece ECG Cable

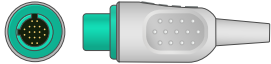
Models	Connector	Options	Part Number	OEM #	Packaging
		5 Leads Grabber	C2596DP0		Case of 10

Spacelabs Disposable ECG Leadwires

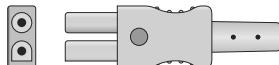
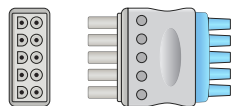
Models	Connector	Options	Part Number	OEM #	Packaging
Spacelabs Tru-Link connector		3 Leads, Grabber	LLB3-90DP0		Case of 10
		5 Leads Grabber	LLB5-90DP0		Case of 10
		3 Leads Grabber	LSL3-90DP0		Case of 10
		5 Leads Grabber	LSL5-90DP0		Case of 10



ECG lead adapters are available to connect any disposable leadwire to any existing monitor trunk cable, standardizing your lead wires and improving inventory management. Call us so one of our experts can assist you in designing the best solution to support your continuum of care.

Can't find what you are looking for?
Call one of our experts at 866-373-6767, we'll help you find it!

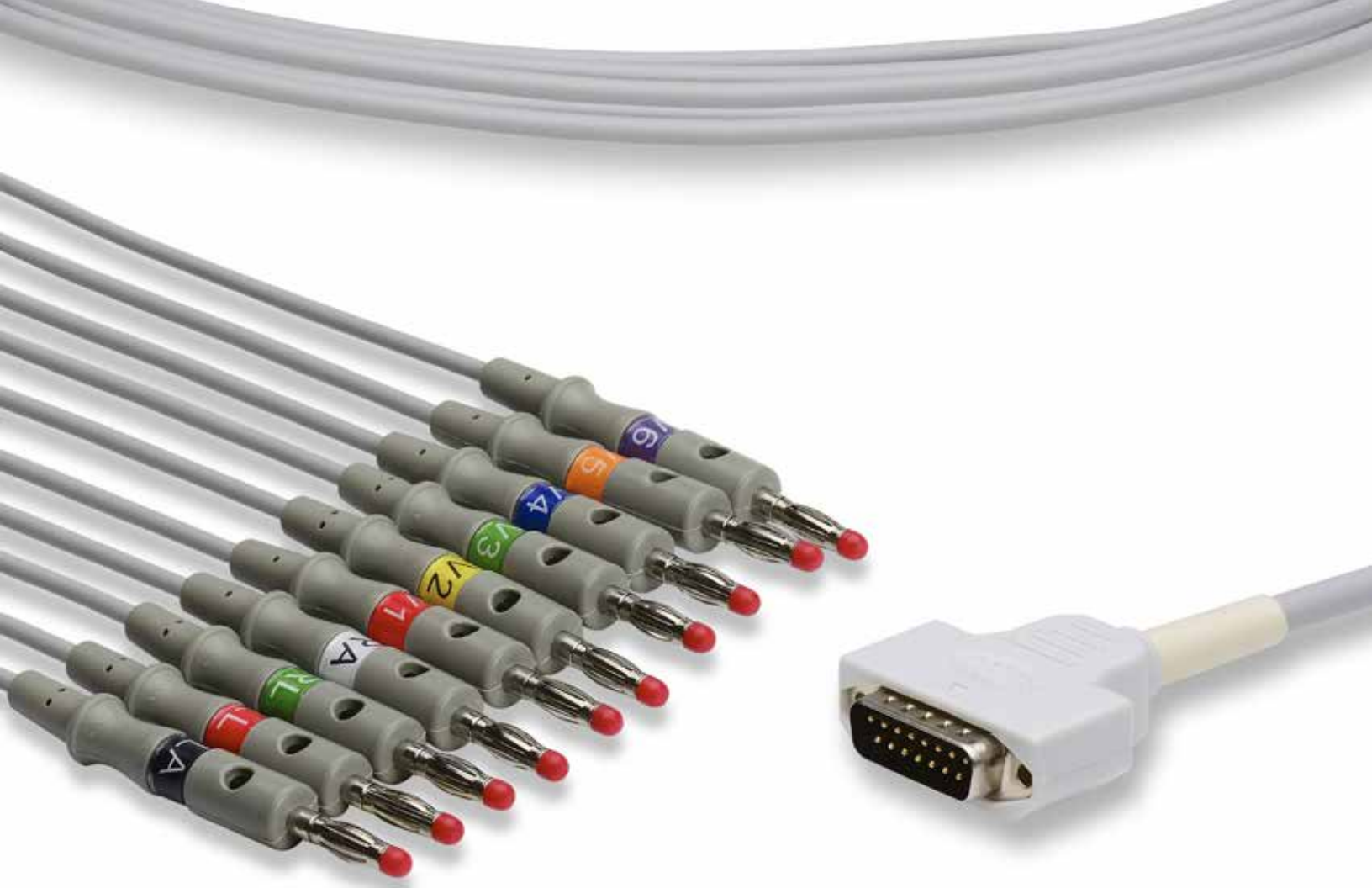

EKG

Compatible patient cables with 10 leads, banana, needle, snap or clip



Choosing your EKG patient cable

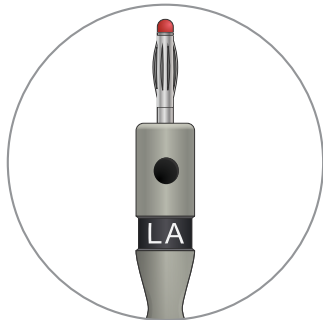

10 Leads Banana (4mm)

Ideal for limb clamps, suction electrodes or with adapters for tab or snap electrode pads.

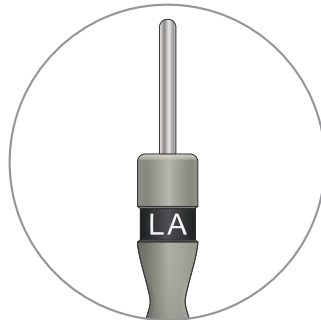

10 Leads Needle (3mm)

Optional terminals for use with limb claps, suction electrodes or with attachments. Smaller, 3mm connection.



10 Leads Snap

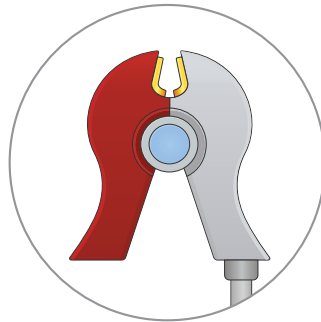

Molded snap endings are best for press stud electrode pads. Select models only.



10 Leads Clip (Grabber)

Molded grabber endings provide quick and easy connection to press stud electrodes. Select models only.

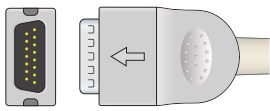
Burdick One Piece EKG Cables

Models	Connector	Options	Part Number	OEM #
EK10, Elite, E350, E350I, E550, E560, Eclipse LE, LE I, Elite II, Quinton Eclipse Plus		10 Leads Banana	K10-BK1-B0	012-0700-00, 007517, 007514, 007705, 007706
		10 Leads Needle	K10-BK1-N0	
		10 Leads Clip	K10-BK1-P0	
Eclipse 4, 300, 400, 800, 850, Plus and Premier, Elite II, Eclipse LE II and Atria Systems, Atria 3000, 3100, 6100		10 Leads Banana	K10-BK2-B0	007704, 007725, 012-0844-00, 012-0844-01, 007785
		10 Leads Needle	K10-BK2-N0	
		10 Leads Clip	K10-BK2-P0	

Cardioline (See Nihon Kohden)

Carewell (See Nihon Kohden)

Edan (See Spacelabs)

Fukuda Denshi One Piece EKG Cables

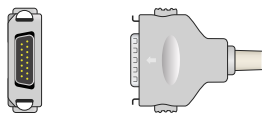
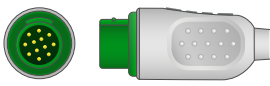
Models	Connector	Options	Part Number	OEM #
FX-101, FX-102F, FX-3010, FX-328UY, FCP 2155, FCP 2201, FCP 4101, FCP 4101A, CardiMax FX-7101, FX-7102, FX-7202, FX-7402		10 Leads Banana	K10-FD1-B0	CP-104L
		10 Leads Needle	K10-FD1-N0	
		10 Leads Clip	K10-FD1-P0	
		12 Leads Snap	KD-21099S0	
		12 Leads Clip	KD-21099P0	

Fukuda ME One Piece EKG Cables

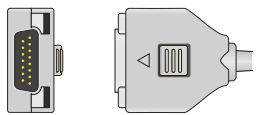
Models	Connector	Options	Part Number	OEM #
KP-500, KP-500D, Cardisuny		10 Leads Banana	K10-FD2-B0	
		10 Leads Needle	K10-FD2-N0	
		10 Leads Clip	K10-FD2-P0	

Hellige One Piece EKG Cables

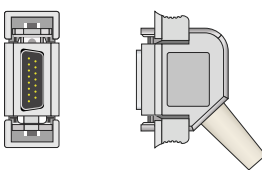
Models	Connector	Options	Part Number	OEM #
		10 Leads Banana	K10-HL-B0	
		10 Leads Needle	K10-HL-N0	
		10 Leads Clip	K10-HL-P0	

Kenz One Piece EKG Cables

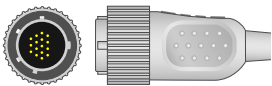
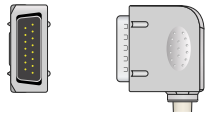
Models	Connector	Options	Part Number	OEM #
103, 106, 107, 302, 303, 1201 and Cardioline Remco Delta 1, Delta 3, Delta 30, Delta 30D, Delta 60, Delta 1 Plus, Delta 3 Plus, Delta 60 Plus, ECG 106		10 Leads Banana	K10-KZ1-B0	PC-104, 63050075, 63050074, 895.0586
		10 Leads Needle	K10-KZ1-N0	
		10 Leads Clip	K10-KZ1-P0	
ECG 108, 110, Cardico 302, 601, 1210, 1211		10 Leads Banana	K10-KZ2-B0	
		10 Leads Needle	K10-KZ2-N0	
		10 Leads Clip	K10-KZ2-P0	

Marquette (GE) One Piece EKG Cables

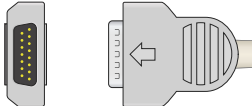
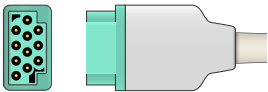
Models	Connector	Options	Part Number	OEM #
MAC 400, MAC 500, MAC 1000, MAC 1100, MAC 1200, MAC 1600, Microsmart M		10 Leads Banana	K10-MQ-B0	
		10 Leads Needle	K10-MQ-N0	
		10 Leads Clip	K10-MQ-P0	
Eagle, Solar, Dash, MAC Lab, Cath Lab and Datex Ohmeda E Prestin module		10 Leads Snap	K21086S0	
		10 Leads Clip	K21086P0	

Marquette (GE) EKG Leads

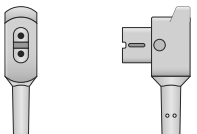
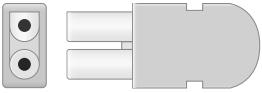
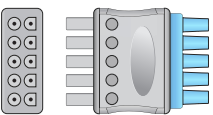
Models	Connector	Options	Part Number	OEM #
AM4 Acquisition Module on monitors including MAC PC, MAC VU, MAC 6, MAC 8, MAC 12, MAC 15, CASE 12, CASE 15, CASE 16, MAX-Personal, MAX-1, CENTRA Systems with AM4 or AM5 Acquisition Modules		10 Leads Banana	LQD10-LB0	900177-203
		10 Leads Clip	LQD10-LP0	
		10 Leads Snap	LQD10-LS0	
		10 Leads Needle	LQD10-LN0	
CAM 14 Acquisition Module or with a cable that requires CAM 14 Leadwires such as GE MAC 1100, 1200, 1200ST, MAC 1600, MAC 3500, MAC 5000, MAC 5000ST, MAC 5500, CASE Series, CASE 8000, CardioSoft, CardioSmart, CardioSys. Please note that these leadwires come with the option of no banana connectors (for use with the GE CAM 14 Electrode Connector Set 900178-001) or molded-in banana, snap, clip or needle connectors		10 Leads Without Adapters	LQB10-AD0	420101-002
		10 Leads Banana	LQB10-LB0	
		10 Leads Snap	LQB10-LS0	
		10 Leads Clip	LQB10-LP0	
		10 Leads Needle	LQB10-LN0	
MAC 400, MAC 500, MAC 1000, MAC 1100, MAC 1200		10 Leads Banana	LQ10-LB0	38401816, 38401817
		10 Leads Needle	LQ10-LN0	
		10 Leads Snap	LQ10-LS0	
		10 Leads Clip	LQ10-LP0	

Marquette (GE) EKG Trunk Cables

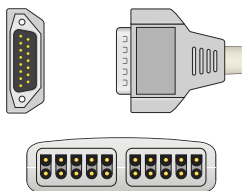
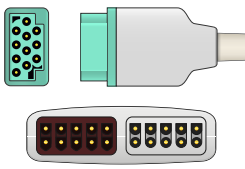
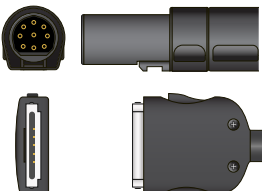
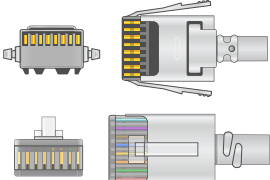
Models	Connector	Options	Part Number	OEM #
MAC 400, MAC 500, MAC 1000, MAC 1100, MAC 1200		10 Leads AHA	T10-MQO	22341809
Eagle, Solar, Dash, Mac Lab, Cath Lab, and Datex Ohmeda E-Prestin and M-Prestin Modules		10 Leads AHA	TQ-210860	2017006-001, 416035-001, 416035-003
MAC 5000 / 5500 Resting ECG System and GE CASE with CAM 14 Acquisition Module. This patient cable connects to the MAC 5000 / 5500 on one side and to the CAM 14 Acquisition Module on the other		Patient Cable, 50 in. (1.3M)	ECAM-GE14-S0	2016560-001, 700657-001
		Patient Cable, 15 ft. (4.6M)	ECAM-GE140	2016560-002, 2016560-003, 700657-003
GE® AM4 and AM5 acquisition modules. For use with GE CASE 12, CASE 15, MAC PC, MAC 6, MAC 12, MAC 15, CENTRA Systems with the AM4 or AM5 acquisition module		Patient Cable, 50 in. (1.3M)	EAM-GE4-S0	700044-203
		Patient Cable, 15 ft. (4.6M)	EAM-GE40	700044-202, 700044-204

Medtronic One Piece EKG Cables

Models	Connector	Options	Part Number	OEM #
Lifepak 11, Lifepak 12, Lifepak 15, Lifepak 20		10 Leads Snap	K21027S0	
		10 Leads Clip	K21027P0	

Mindray (See Spacelabs)

Mortara One Piece EKG Cables

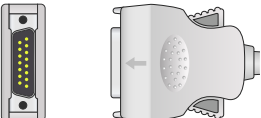
Models	Connector	Options	Part Number	OEM #
ELI 10, ELI 50, ELI 100, ELI 150, ELI 150C, ELI 200, ELI 210, ELI 230, ELI 250, ELI 250C and ELI 350		10 Leads Banana	K10-MT-B0	9293-032-50, 9293-040-50
		10 Leads Needle	K10-MT-N0	
		10 Leads Clip	K10-MT-P0	9293-042-50
		10 Leads Snap	K10-MT-S0	9293-033-50

Nihon Kohden One Piece EKG Cables

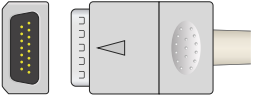
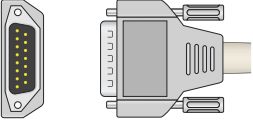
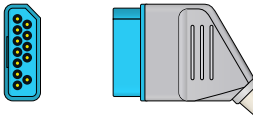
Models	Connector	Options	Part Number	OEM #
Cardiofax, 6151, 6851, 6353, 8110, 8330, 8330A, Escape 12, Edan Smart ECG, Danatech, and Dr. Lee EKGs 120B		10 Leads Banana	K10-NK1-B0	
		10 Leads Needle	K10-NK1-N0	
		10 Leads Clip	K10-NK1-P0	
Cardiofax Q, 1350, ECG-1250A, ECG-9620, ECG-9010, ECG-9020, ECG-9022, ECG-9110, ECG-9130, ECG-9132, ECG-9110K, ECG-9130K, Cardioline (new line), Del Mar Reynolds Voyager 12; Newtech 1206; Carewell 1103, Carewell AR 1200ADV		10 Leads Banana	K10-NK2-B0	BA-902D
		10 Leads Needle	K10-NK2-N0	BA-901D
		10 Leads Clip	K10-NK2-P0	BA-903D
		10 Leads Snap	K21009S0	
		10 Leads Clip	K21009P0	BJ-900P

Philips HP One Piece EKG Cables

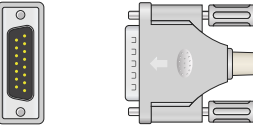
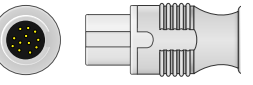
Models	Connector	Options	Part Number	OEM #
M1770A, M1771A, M1772A, PageWriter 100, 200, 200i and Agilent 300i, 300PI; CardioTech CRT-6U, CRT-6D, CRT-6T; Bionet Cardiacare 2000; Delmar Reynolds CardioCollect 12; BLT-08 LT ECG; Spacelabs CardioDirect 12; Woodway Cortex CPX System; Welch Allyn CP 100 and CP 200		10 Leads Banana	K10-HP-B0	M2461A, M3702C, M3703C, 400293 + 401129, 45502-13
		10 Leads Needle	K10-HP-N0	
		10 Leads Clip	K10-HP-P0	
Codemaster 100		10 Leads Snap	KP-21085S0	
		10 Leads Clip	KP-21085P0	

Philips HP EKG Leads

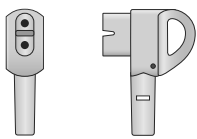
Models	Connector	Options	Part Number	OEM #
Trim, Trim I, Trim II (989803130101), Trim III, PageWriter TC30, PageWriter TC50, PageWriter XLI M1700A, PageWriter XLE 1702A, Touch EKG Machines		10 Leads Banana	LW10-LB0	989803129161, M1713B, M1716B, M1702A
		10 Leads Clip	LW10-LP0	
		10 Leads Snap	LW10-LS0	
		10 Leads Needle	LW10-LN0	

Philips HP EKG Trunk Cables

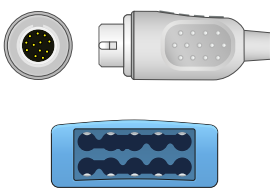

Models	Connector	Options	Part Number	OEM #
78352C, 78354C, 78834C Legacy HP Monitors, Modules M1001A/B, M1002A/B, M3001A Opt. C12 or Opt. C18, IntelliVue Multi-Measurement Modules M3002A, Opt. C12, MMS X2, M8102A Opt. C12, MP2 Monitor, M8105A Opt. C12, MP5 Monitor, M3535A/M3536A, HeartStart MRx Defibrillator/Monitor. For use with M1644A (LPA5-90S0) and M1602A (LPB5-90S0) lead set		10 Leads AHA	TP-210850	M1663A, M1949A, M3525A, 989803125831

Physio Control (See Medtronic)

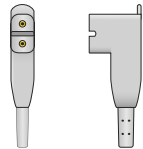
Quinton EKG Leads

Models	Connector	Options	Part Number	OEM #
Quinton Q710 stress machine		10 Leads Banana	LT10-LB0	031257-002
		10 Leads Snap	LT10-LS0	
		10 Leads Clip	LT10-LP0	
		10 Leads Needle	LT10-LN0	

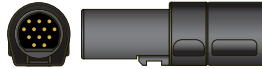
Quinton One Piece EKG Cables

Models	Connector	Options	Part Number	OEM #
Burdick/Quinton Q-Stress Treadmill System		10 Leads Banana	K10-BK3-B0	
		10 Leads Snap	K10-BK3-S0	60-00181-01, 60-00185-01
		10 Leads Clip	K10-BK3-P0	60-00180-01, 60-00184-01, 042051-005
Burdick/Quinton Q750, Q-4500 systems		10 Leads Banana	K10-QT-B0	019420-003
		10 Leads Snap	K10-QT-S0	
		10 Leads Clip	K10-QT-P0	

Schiller One Piece EKG Cables

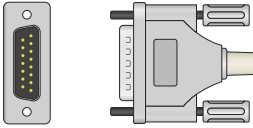
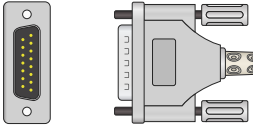
Models	Connector	Options	Part Number	OEM #
AT-1, AT-2, AT-2 Light, AT-2 Plus, AT-4, AT-10, AT-10 Plus, AT-60, AT-101, AT-102, AT-102-Plus, AT-104, AT-110, CS-100, CS-200, MS-2010, MS-2015; Bionet: CardioCare 2000; Esaote: P80 Series 40893, Biosound MyLab 30 CD, 30 CV; Cardiette: AR1200 adv; Welch Allyn CP10, CP20		10 Leads Banana	K10-SH1-B0	2.400095, 2.400071S, 2.40071E, MD07J, 80130-0000, 9293-032-60
		10 Leads Needle	K10-SH1-N0	
		10 Leads Clip	K10-SH1-P0	
AT3, AT6, CS6, AT5, AT10, AT60, CS-200; Bionet Cardiotouch		10 Leads Banana	K10-SH2-B0	
		10 Leads Needle	K10-SH2-N0	
		10 Leads Clip	K10-SH2-P0	

Spacelabs One Piece EKG Cables (Also see Philips HP)

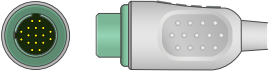
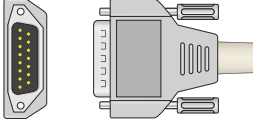
Models	Connector	Options	Part Number	OEM #
		12 Leads Snap	KL-21096S0	
		12 Leads Clip	KL-21096P0	
Spacelabs SL6, Mindray DECG-03A, Edan SE-3, SE-12, SE-12 Express, SE-601A, SE-601B, SE-601C, SE-1010PC, SE-1200, SE-12 Express, ST-1212 and Nihon Kohden BSM-2301K		10 Leads Banana	K10-ED-B0	01.57.107048
		10 Leads Needle	K10-ED-N0	
		10 Leads Clip	K10-ED-P0	

Welch Allyn EKG Leads *(Also see Schiller)*

Models	Connector	Options	Part Number	OEM #
For use with the 400293 10-lead patient cable on models CP100, CP200		10 Leads Banana	LWA10-LB0	401129
		10 Leads Snap	LWA10-LS0	
		10 Leads Clip	LWA10-LP0	
		10 Leads Needle	LWA10-LN0	

Zoll One Piece EKG Cables

Models	Connector	Options	Part Number	OEM #
1 Step Patient Cable for E Series and M Series defibrillators. Includes trunk cable and limb and V leads		10 Leads Snap	K21069S0	8000-1007-01, 8000-1007-02
		10 Leads Clip	K21069P0	



Limb Electrode Clamps

Details	Connector	Options	Part Number	OEM #
Adult and pediatric extremities, needle (3mm) / banana (4mm) red, black, green and yellow or one single color (green)		Adult Multiple Colors, Box of 4	RU-LC-AO	2029894-001, 714731, 989803101691, 40494E
		Pediatric Multiple Colors	RU-LC-PO	
		Adult Green, Box of 4	RU-LC-AAO	
		Pediatric Green, Box of 4	RU-LC-PAO	

Precordial Suction Electrodes

Details	Connector	Options	Part Number	OEM #
Adult and pediatric universal, needle (3mm) / banana (4mm), 6 per box		Adult Blue, Box of 6	RU-SE-AO	40421A, 2029829-001, 714730
		Pediatric Green, Box of 6	RU-SE-PO	



EKG Leadwire Adapters

Details	Connector	Options	Part Number	OEM #
Banana (4mm) to Snap		Set of 10 Adapters	AD-BS-100	
Banana (4mm) to Clip		Set of 10 Adapters	AD-BP-100	

EKG Leadwire Adapters (Continued)

Details	Connector	Options	Part Number	OEM #
Banana (4mm) to "tab" electrodes such as the Nikotab® electrodes		Set of 10 Adapters	AD-BW-100	ADA34, CL-A34, 989803166031, 9490-210, 2056813-010, 9490-214
Needle (3mm) to "tab" electrodes such as the Nikotab® electrodes		Set of 10 Adapters	AD-NW-100	M2254A, 989803106061
Banana (4mm) to Snap		Set of 10 Adapters	AD-B-S0	
Banana (4mm) to Clip		Set of 10 Adapters	AD-B-P0	40498E, 989803101701
Needle (3mm) to Snap		Set of 10 Adapters	AD-N-S0	
Needle (3mm) to Clip		Set of 10 Adapters	AD-N-P0	

EKG Leadwire Adapters (Continued)

Details	Connector	Options	Part Number	OEM #
Banana (4mm) to Alligator		Set of 10 Adapters	AD-BA-100	ADAK10, 58581-000, 9490-105
Needle (3mm) to Alligator		Set of 10 Adapters	AD-NA-100	AD125, 98980312931, 9490-106
Adapter for GE CAM 14, AM4 or AM5 (LQB10-AD0)		Set of 10 Adapters Banana	AD10-DB0	900178-001
		Set of 10 Adapters Clip	AD10-DP0	900178-003
		Set of 10 Adapters Snap	AD10-DS0	

Vet ECG Alligator Electrode Clip

Description	Image	Options	Part Number	OEM #
This reusable electrode is for use with snap leadwires to apply directly on the animal's skin.		Sold by Each	UVC-050	9101-20-58104

Would one of your colleagues benefit from having a copy of this catalog? Please let us know, we'll ship one out! Call us at 866-373-6767.



NIBP

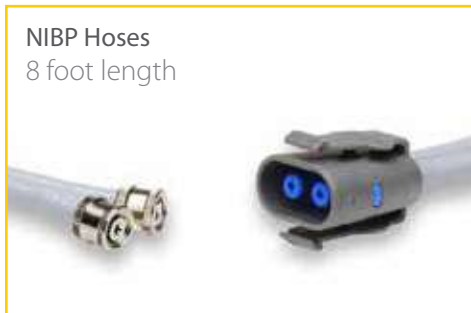

Hoses, reusable and disposable cuffs and connectors



Bionet (See Quick-Release NIBP Hose)

Criticare (See Nihon Kohden and Quick-Release NIBP Hose)

Colin NIBP Hose (Also see Nihon Kohden)

Models	Hose	Options	Part Number	OEM #
		Adult NIBP Hose	AS-31-320	A015ZZ
		Neonate NIBP Hose	ASN-31-200	

Corometrics (See Marquette)



Critikon (See Nihon Kohden)

Datascope (See Nihon Kohden and Quick-Release NIBP Hose)



Dinamap NIBP Hose

Models	Hose	Options	Part Number	OEM #
Dinamap ProCare, Pro Series, Pro 1000 and Critikon Compact BP		Adult NIBP Hose	AD-25-090	107365
		Neonate NIBP Hose	ADN-25-270	107368

Datex Ohmeda NIBP Hose

Models	Hose	Options	Part Number	OEM #
Datex Ohmeda AS/3, CS/3, S/5, Cardiocap 5, Cardiocap II, Light		Adult NIBP Hose	AD-22-17/180	877235
		Neonate NIBP Hose	ADN-22-270	877514

Drager NIBP Hose

Models	Hose	Options	Part Number	OEM #
Siemens Drager SC6000, SC7000, SC8000, SC9000, Infinity Delta, Vista, Kappa, Gamma		Adult NIBP Hose	AS-40-150	MP00953, 1275 275 EH5OU, 1275 275 E07
		Neonate NIBP Hose	ASN-40-200	2870298

Edan (See Quick-Release NIBP Hose)

Goldway (See Quick-Release NIBP Hose)







Infinium NIBP Hose

Models	Hose	Options	Part Number	OEM #
Omni 2 and Omni 3		Adult NIBP Hose	AS-36-2T0	



Invivo (See Nihon Kohden)

Kontron (See Nihon Kohden and Quick-Release NIBP Hose)

Marquette (GE) NIBP Hose

Models	Hose	Options	Part Number	OEM #
Dash, Eagle, Solar, Tram 400, Tram 450, Tram 451, Tram 800, Tram 850, Tram 851, Corometrics 120 and Corometrics 250, Carescape B850		Adult NIBP Hose	AD-24-170	414873-001, 9461-217, 2020980-001, 2017008-001
		Neonate NIBP Hose	ADN-24-270	414874-001
Eagle 4000, Solar, Tram 100, Tram 200 and Tram 300		Adult NIBP Hose	AD-22-170	9461-203
		Neonate NIBP Hose	ADN-22-270	877514
Eagle 3000, Dash 2000, Dash 3000, Dash 4000, Dash 5000 and Corometrics 120		Adult NIBP Hose	AD-24-090	2017008-003
		Neonate NIBP Hose	ADN-24-200	

Medtronic NIBP Hose

Models	Hose	Options	Part Number	OEM #
Lifepak 12 and Lifepak 20		Adult NIBP Hose	AS-12-150	
		Neonate NIBP Hose	ASN-12-200	





MEK (See Welch Allyn)

Mennen (See Welch Allyn)



Mindray (See Quick-Release NIBP Hose)

Nellcor (See Quick-Release NIBP Hose)



Nihon Kohden NIBP Hose

Models	Hose	Options	Part Number	OEM #
		Adult NIBP Hose	AD-09-090	8841
		Neonate NIBP Hose	ADN-09-270	8840
Life Scope OPV 1500K, BSM-2351A, BSM-4102, BSM-4102A, Life Scope TR, BSM-6000 series, BSM-6301K, BSM-6501K, BSM-6701K, Life Scope J, BSM-9101, PVM-2701		Adult NIBP Hose	AD-30-180	YN-900P, YN-901P
		Neonate NIBP Hose	AND-30-200	YN-920P, YN-921P

Nihon Kohden NIBP Hose (Continued)



Models	Hose	Options	Part Number	OEM #
Nihon Kohden, Criticare: 507E/P/R, 507N/P, 507S/SD, 5070/P, 1100, 2200; Datascope, Colin, Welch Allyn		Adult NIBP Hose	AS-04-070	709
		Neonate NIBP Hose	ASN-04-200	

Philips NIBP Hose (Also see Quick-Release NIBP Hose)

Models	Hose	Options	Part Number	OEM #
M1008B and all Philips monitors except for A1 and A3		Adult NIBP Hose	AS-16-150	M1599A, M1599B, M1598B, 989803104341
		Neonate NIBP Hose	ASN-16-200	M1596B, M1597B

Physio Control (See Medtronic)



Quick-Release NIBP Hose

Models	Hose	Options	Part Number	OEM #
Bionet: BMP300; Criticare: 506 series, 507EL/C, 507NJC, 507MPS, 8100 series; Datascope: Accutorr V, Duo, Passport 2, Passport V, Spectrum, Spectrum OR, Trio, V12, V21; Edan; Goldway; Kontron; Mindray T5; Nellcor; Ohmeda: enGuard CMS; Penlon; Philips: A1 and A3; Siemens; Spacelabs		Adult NIBP Hose	AS-15-150	200683-04-0003, 200683-04-0004, 509B-30-06259, 0683-00-0189-80, 705, 706, 708, M3918A, 714-0060-00, 714-0061-00, 714-0018-00
		Neonate NIBP Hose	ASN-15-200	708



Siemens (See Drager and Quick-Release NIBP Hose)

Spacelabs (Also see Quick-Release NIBP Hose)

Welch Allyn NIBP Hose (Also see Nihon Kohden)

Models	Hose	Options	Part Number	OEM #
MEK MP 700, MP 1000 and Welch Allyn Propaq Encore		Adult NIBP Hose	AS-09-090	
		Neonate NIBP Hose	ASN-09-200	
Welch Allyn Atlas and Mennen monitors		Adult NIBP Hose	AS-04-090	
		Neonate NIBP Hose	ASN-04-200	
Spot Vital Signs LXi		Adult NIBP Hose	AD-41-090	4500-32

Zoll NIBP Hose

Models	Hose	Options	Part Number	OEM #
M Series and E Series defibrillators		Adult NIBP Hose	AS-15-170	8000-0655, 8000-0662
		Neonate NIBP Hose	ASN-15-200	
				

Reusable NIBP Cuffs

Description	Hose	Options	Part Number
Universal, reusable cuffs, sold individually. Connectors sold separately.		Adult (25 - 35cm) Single Hose	F1880S0
		Adult (25 - 35cm) Double Hose	F1880D0
		Large Adult (33-47cm) Single Hose	F1869S0
		Large Adult (33-47cm) Double Hose	F1869D0
		Small Adult (17-26cm) Single Hose	F1885S0
		Small Adult (17-26cm) Double Hose	F1885D0
		Pediatric (18-26cm) Single Hose	F1881S0
		Pediatric (18-26cm) Double Hose	F1881D0
		Infant (10-19cm) Single Hose	F1882S0
		Infant (10-19cm) Double Hose	F1882D0
		Neonate (6-11cm) Single Hose	F1883S0
		Neonate (6-11cm) Double Hose	F1883D0
		Thigh (46-66cm) Single Hose	F1884S0
		Thigh (46-66cm) Double Hose	F1884D0

Neonate Disposable NIBP Cuffs

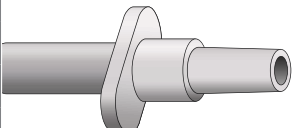
Description	Hose	Options	Part Number
Disposable neonate NIBP cuffs in 5 sizes, sold in cases of 10 units.		Single Hose #1 (3-6cm)	F1781S-C05-100
		Double Hose #1 (3-6cm)	F1781D-C05-100
		Single Hose #2 (4-8cm)	F1782S-C05-100
		Double Hose #2 (4-8cm)	F1782D-C05-100
		Single Hose #3 (6-11cm)	F1783S-C05-100
		Double Hose #3 (6-11cm)	F1783D-C05-100
		Single Hose #4 (7-13cm)	F1784S-C05-100
		Double Hose #4 (7-13cm)	F1784D-C05-100
		Single Hose #5 (8-15cm)	F1785S-C05-100
		Double Hose #5 (8-15cm)	F1785D-C05-100

All Size Disposable NIBP Cuffs

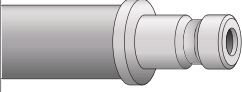
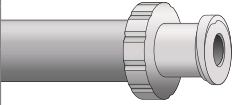
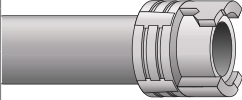
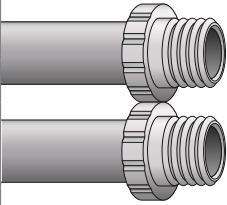
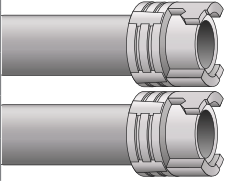
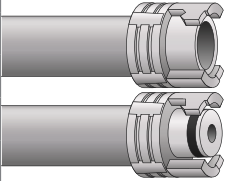
Description	Hose	Options	Part Number
<p>Datascope, Drager, Philips, Siemens, and Spacelabs monitors. Sold in cases of 5 units. Each cuff comes with a molded BP12 plastic NIBP connector.</p> 		Adult (23-33cm) Single Hose	F1740S-C12-050
		Large Adult (31-40cm) Single Hose	F1720S-C12-050
		Small Adult (17-25cm) Single Hose	F1750S-C12-050
		Pediatric (12-19cm) Single Hose Cuff	F1760S-C12-050
		Infant (8-13cm) Single Hose	F1770S-C12-050
		Thigh (38-50cm) Single Hose	F1790S-C12-050
<p>Colin, Datascope and Spacelabs monitors. Available in cases of 5 units. Each cuff comes with a molded BP03 plastic NIBP connector.</p> 		Adult (23-33cm) Single Hose	F1740S-C03-050
		Large Adult (31-40cm) Single Hose	F1720S-C03-050
		Small Adult (17-25cm) Single Hose	F1750S-C03-050
		Pediatric (12-19cm) Single Hose Cuff	F1760S-C03-050
		Infant (8-13cm) Single Hose	F1770S-C03-050
		Thigh (38-50cm) Single Hose	F1790S-C03-050
<p>Available in cases of 5 units. Each cuff comes with a molded BP18 plastic NIBP connector.</p> 		Adult (23-33cm) Single Hose	F1740S-C18-050
		Large Adult (31-40cm) Single Hose	F1720S-C18-050
		Small Adult (17-25cm) Single Hose	F1750S-C18-050
		Pediatric (12-19cm) Single Hose Cuff	F1760S-C18-050
		Infant (8-13cm) Single Hose	F1770S-C18-050
		Thigh (38-50cm) Single Hose	F1790S-C18-050
<p>GE Corometrics, Dinamap and MDE monitors. Available in cases of 5 units. Each hose comes with a molded BP08 plastic NIBP connector incorporated.</p> 		Adult (23-33cm) Double Hose	F1740D-C0808-050
		Large Adult (31-40cm) Double Hose	F1720D-C0808-050
		Small Adult (17-25cm) Double Hose	F1750D-C0808-050
		Pediatric (12-19cm) Double Hose	F1760D-C0808-050
		Infant (8-13cm) Double Hose	F1770D-C0808-050
		Thigh (38-50cm) Double Hose	F1790D-C0808-050
<p>GE Eagle, Dash, Tram, Solar and MAC-LAB monitors. Available in cases of 5 units. Each hose comes with a molded BP18 plastic NIBP connector incorporated.</p> 		Adult (23-33cm) Double Hose	F1740D-C1818-050
		Large Adult (31-40cm) Double Hose	F1720D-C1818-050
		Small Adult (17-25cm) Double Hose	F1750D-C1818-050
		Pediatric (12-19cm) Double Hose	F1760D-C1818-050
		Infant (8-13cm) Double Hose	F1770D-C1818-050
		Thigh (38-50cm) Double Hose	F1790D-C1818-050
<p>Datex Ohmeda monitors. Available in cases of 5 units. Each hose comes with a molded BP17 and BP18 plastic NIBP connector.</p> 		Adult (23-33cm) Double Hose	F1740D-C1718-050
		Large Adult (31-40cm) Double Hose	F1720D-C1718-050
		Small Adult (17-25cm) Double Hose	F1750D-C1718-050
		Pediatric (12-19cm) Double Hose	F1760D-C1718-050
		Infant (8-13cm) Double Hose	F1770D-C1718-050
		Thigh (38-50cm) Double Hose	F1790D-C1718-050



NIBP Connectors

Connector	Image Src	Description	Part Number
BP03 NIBP Connector		NIBP luer-lock connector for use with Mennen (Old), Shchiller, Spacelabs (Old). Connects to BP06	BP03
BP04 NIBP Connector		NIBP luer-style connector for use with Mennen (Old), Shchiller, Spacelabs (Old). Connects to BP07.	BP04
BP05 NIBP Connector		NIBP connector for use with CAS Med, Drager, Kontron, Physio Control (Old), Schiller. Connects to BP20. Generally used for neonate cuffs.	BP05
BP06 NIBP Connector		NIBP connector for use with BCI (Older versions), Datascope (Older versions). Connects to BP03.	BP06
BP07 NIBP Connector		NIBP connector for use with BCI (Older versions), Datascope (Older versions). Connects to BP04.	BP07
BP08 NIBP Connector		NIBP connector for use with Critikon, Invivo (requires 2), Kontron (requires 2), Mennen (requires 2), Nihon Kohden (requires 2), Welch Allyn. Connects to BP09.	BP08
BP09 NIBP Connector		NIBP threaded connector for use with Critikon, Invivo (requires 2), Kontron (requires 2), Mennen (requires 2), Nihon Kohden (requires 2), Welch Allyn. Connects to BP08.	BP09
BP12 NIBP Connector		NIBP connector for use with Criticare, Datascope, Drager, Siemens, Physio Control, Mindray, Philips, Spacelabs. Connects to BP15.	BP12
BP12-P NIBP Connector		NIBP connector for use with Criticare, Datascope, Drager, Siemens, Physio Control, Mindray, Philips, Spacelabs. Connects to BP15.	BP12-P

NIBP Connectors (Continued)

Connector	Image Src	Description	Part Number
BP15 NIBP Connector		NIBP bayonet-style connector for use with Schiller and Infinium One. Connects to BP12.	BP15
BP16 NIBP Connector		NIBP connector for use with Philips. Connects to Philips monitors.	BP16
BP17 NIBP Connector		NIBP quick-connect connector for use with Datex Ohmeda, Marquette, Zoll M Series. Connects to BP18.	BP17
BP18 NIBP Connector		NIBP quick-connect connector for use with Datex Ohmeda, Marquette, Zoll M Series. Connects to BP17.	BP18
BP20 NIBP Connector		NIBP connector for use with neonate NIBP Hoses. Connects to BP05.	BP20
BP21 NIBP Connector		NIBP connector for use with Pace Tech monitors.	BP21
BS21 NIBP Connector		BS21 monitor socket. Connects to BP21.	BS21
BP22 NIBP Connector		NIBP connector for use with GE Datex AS/3, CS/3, S/5, Cardiocap 5, Cardiocap II, Eagle 4000, Solar, Tram monitors.	BP22
BP25 NIBP Connector		NIBP connector for use with Dinamap monitors.	BP25

NIBP Connectors (Continued)

Connector	Image Src	Description	Part Number
BP31 NIBP Connector		NIBP connector for use with Colin monitors.	BP31
BP32 NIBP Connector		NIBP connector for use with Colin monitors.	BP32
"Y" NIBP Connector		"Y" NIBP adapter to convert a double NIBP hose to a single NIBP hose.	BP3T-Y0

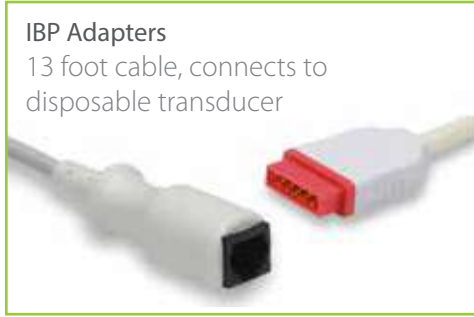

IBP

Compatible IBP adapters, converter cables and disposable transducers

Choosing your IBP adapter cable

IBP adapters are available with the following connectors for use with all of the major disposable transducer brands:

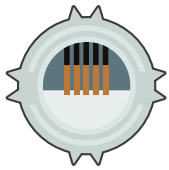

Argon

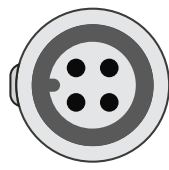

B. Brown

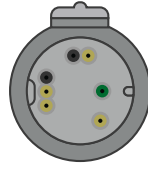

BD

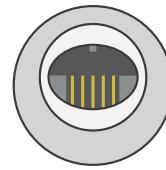

Edwards

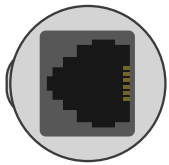

Medex Abbott

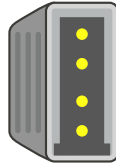

Utah



Medex Logical

6-Pin IBP Adapter

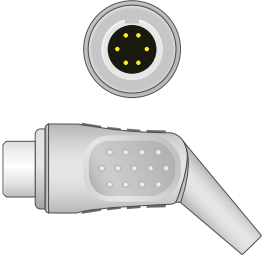
Models	Adapter	Options	Part Number	OEM #
IBP adapter cable for Bard H8000 Intra Aortic Balloon Pump (No Cal); BCI 9100 Series and 9200 Advisor Series; Critikon; Digicare; Dixtal DX-2020, DX-2021, and DX-2023; Genera 710C; Hewlett Packard 5microvolt, (Option 002) 8805, 78205; Invivo Corporation/Medical Data Electronics (NDE), Inc. TVS Omnitrak, Omnitrak 4000, Millenia, Model 3550 Escort M12, Escort 100 - 200 - and 300 Series, MDE, Series 3100 - 3500; Ivy Biomedical 700, 400 Series; Medical Research Laboratories - Welch Allyn Portable Invasive Care (PIC); Mindray / Datascope Passport; Mennen; Nellcor Escort; Omni-Trak 4000; PaceTech VitalMax 4000 Modular; Physio Control Lifepak 12; Smiths Medical; Spacelabs 300, 400, 500, 600, Alpha 7, Alpha PC, 90308, 90311, 90331, 90402, 90403, 90470, 90496*, 90603A, 91496*, PC Express, 700 Surgical Series, MOD-CD, Tel/Vitatek, Scout TPC *90496 and 91496 require Spacelabs 700-0028-00 rectangular jumper cable; Tecktronix 400 Series; Vitalert 2000; Viatek; Welch Allyn Propaq 102, 104, 106 Acuity, 106EL, Encore; Zoll Defibrillators		For Argon Transducers	IC-6P-AG0	
		For B. Braun Transducers	IC-6P-BB0	
		For BD Transducers	IC-6P-BD0	001C-30-70758, 684085
		For Edwards Transducers	IC-6P-ED0	0010-21-43094
		For Medex Abbott Transducers	IC-6P-MX0	
		For Utah Transducers	IC-6P-UT0	650-208
		For Medex Logical Transducers	IC-6P-MX10	

Air Shields (See Datex Ohmeda)

BCI (See 6-Pin IBP Adapter)

Burdick (See Datex Ohmeda)

Colin (See Datascope)

Criticare IBP Adapter

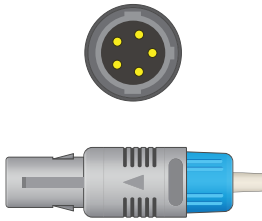
Models	Adapter	Options	Part Number	OEM #
Criticare Matrix, Scholar 2200		For Argon Transducers	IC-CSI-AG0	
		For B. Braun Transducers	IC-CSI-BB0	
		For BD Transducers	IC-CSI-BD0	684175
		For Edwards Transducers	IC-CSI-ED0	
		For Medex Abbott Transducers	IC-CSI-MX0	
		For Utah Transducers	IC-CSI-UT0	
		For Medex Logical Transducers	IC-CSI-MX10	

Critikon (See 6-Pin IBP Adapter)

Datascope IBP Adapter (Also see 6-Pin IBP Adapter)

Models	Adapter	Options	Part Number	OEM #
American Optical 1131 Module; Colin 408BP, 400 Series; CWE Research Lab Monitor; Datascope System IA Balloon Pump 95, 97, 98, 98XT, CS100, CS300, 2000, 2000A, 2001, 2002, 3000, Passport, Passport II, Passport XG, Spectrum, Spectrum OR, Trio; Hewlett Packard Sandborn, INEX; Kontron (Roche) 2106, 7320, 7324 (BP Module for 7046 & 7048); Marquette 3100 Series		For Argon Transducers	IC-DT-AG0	
		For B. Braun Transducers	IC-DT-BB0	
		For BD Transducers	IC-DT-BD0	684078
		For Edwards Transducers	IC-DT-ED0	
		For Medex Abbott Transducers	IC-DT-MX0	
		For Utah Transducers	IC-DT-UT0	650-204
		For Medex Logical Transducers	IC-DT-MX10	
Datascope Passport V, V12, V21		For Argon Transducers	IC-DT1-AG0	
		For B. Braun Transducers	IC-DT1-BB0	
		For BD Transducers	IC-DT1-BD0	040-000053-00
		For Edwards Transducers	IC-DT1-ED0	040-000054-00
		For Medex Abbott Transducers	IC-DT1-MX0	
		For Utah Transducers	IC-DT1-UT0	
		For Medex Logical Transducers	IC-DT1-MX10	

Datex Ohmeda IBP Adapter

Models	Adapter	Options	Part Number	OEM #
Air-Shields AS-100 (141 Module), AS-441; Burdick M500 Series M544 Module (M560/M565/M575 Mainframe); Diascope Traveler/North American; GE Datex Ohmeda AS/3, AS/5, ESTP Module, CC-104, Cardiopac CM-104, Cardiopac I and II, Cardiopac 5; Kone M500 Series M544 Module (M560/ M565/ M575 Mainframe); Puritan - Bennett PB 240, PB 245, PB 245P; Simonson & Weil AS100 Series, Athena System, 8000 Quadrascope		For Argon Transducers	IC-DX-AG0	
		For B. Braun Transducers	IC-DX-BB0	
		For BD Transducers	IC-DX-BD0	
		For Edwards Transducers	IC-DX-ED0	684104
		For Medex Abbott Transducers	IC-DX-MX0	
		For Utah Transducers	IC-DX-UT0	650-217
		For Medex Logical Transducers	IC-DX-MX10	

Drager IBP Adapter

Models	Adapter	Options	Part Number	OEM #
Siemens Axiom Sensis XP with Hemopod, 3rds Generation Sirecust 400 Series, 630, 700, 732, 960, 961, 1241, 1260, 1280, 1281, 4041, SC6000, SC6002, SC6002 XL, SC6802 XL, Gamma XL, Vista XL, SC7000, SC8000, SC9000, SC9000 XL, Delta, Delta XL		For Argon Transducers	IC-SM1-AG0	
		For B. Braun Transducers	IC-SM1-BB0	
		For BD Transducers	IC-SM1-BD0	684082
		For Edwards Transducers	IC-SM1-ED0	
		For Medex Abbott Transducers	IC-SM1-MX0	
		For Utah Transducers	IC-SM1-UT0	650-203
		For Medex Logical Transducers	IC-SM1-MX10	

Drager IBP Adapter (Continued)

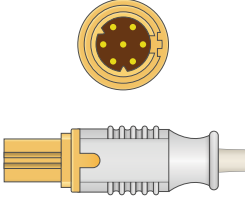
Models	Adapter	Options	Part Number	OEM #
Drager Infinity Vista, Delta Kappa		For Argon Transducers	IC-SM2-AGO	
		For B. Braun Transducers	IC-SM2-BB0	
		For BD Transducers	IC-SM2-BD0	MS22148, 3375933
		For Edwards Transducers	IC-SM2-ED0	MS22147
		For Medex Abbott Transducers	IC-SM2-MX0	MS22535
		For Utah Transducers	IC-SM2-UT0	MS22534
		For Medex Logical Transducers	IC-SM2-MX10	

Marquette (GE) IBP Adapter

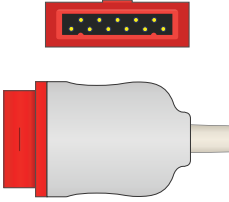
Models	Adapter	Options	Part Number	OEM #
GE Marquette Eagle, Dash 1000, Dash 2000, Dash 3000, Dash 3100, Dash 4000, Solar 7000, Solar 8000, Solar 9000, Tram Module 100-600, Cath Lab, MAC-Lab, Tram Scope 100-800 A or L Series, Tram Rac 3, Tram Rac 4A; Datex Ohmeda AM Module E-PRESTN		For Argon Transducers	IC-MQ-AGO	
		For B. Braun Transducers	IC-MQ-BB0	22339301
		For BD Transducers	IC-MQ-BD0	700077-001, 684102
		For Edwards Transducers	IC-MQ-ED0	2021197-001
		For Medex Abbott Transducers	IC-MQ-MX0	700075-001
		For Utah Transducers	IC-MQ-UT0	700078-001, 650-236
		For Medex Logical Transducers	IC-MQ-MX10	

Hellige IBP Adapter

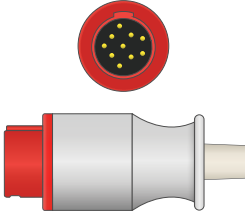
Models	Adapter	Options	Part Number	OEM #
		For Argon Transducers	IC-HL-AGO	
		For B. Braun Transducers	IC-HL-BB0	
		For BD Transducers	IC-HL-BD0	
		For Edwards Transducers	IC-HL-ED0	
		For Medex Abbott Transducers	IC-HL-MX0	
		For Utah Transducers	IC-HL-UT0	
		For Medex Logical Transducers	IC-HL-MX10	

Infinium IBP Adapter

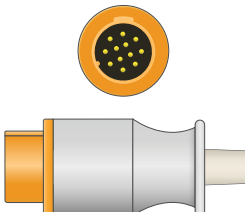
Models	Adapter	Options	Part Number	OEM #
Arrow KAAT I Plus and II Plus; DRE Waveline and Vida; Infinium Procyon and Vega; Kontron Minimon, Supermon, Fetalmon 2B Fetalogic 4000, K2000, IAB Balloon Pump, 7000 Series, Aero KAAT II Plus		For Argon Transducers	IC-KTN-AGO	
		For B. Braun Transducers	IC-KTN-BB0	
		For BD Transducers	IC-KTN-BD0	
		For Edwards Transducers	IC-KTN-ED0	
		For Medex Abbott Transducers	IC-KTN-MX0	
		For Utah Transducers	IC-KTN-UT0	650-230
		For Medex Logical Transducers	IC-KTN-MX10	

Invivo (See 6-Pin IBP Adapter)

IVY Biomedical (See 6-Pin IBP Adapter)

Kontron (See Infinium)

Medtronic (See 6-Pin IBP Adapter)

MEK IBP Adapter

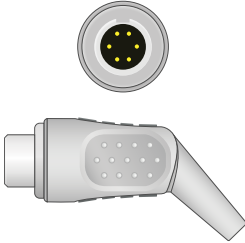
Models	Adapter	Options	Part Number	OEM #
		For Argon Transducers	IC-MEK-AGO	
		For B. Braun Transducers	IC-MEK-BBO	
		For BD Transducers	IC-MEK-BDO	
		For Edwards Transducers	IC-MEK-EDO	
		For Medex Abbott Transducers	IC-MEK-MX0	
		For Utah Transducers	IC-MEK-UTO	
		For Medex Logical Transducers	IC-MEK-MX10	

Mennen IBP Adapter (Also see 6-Pin IBP Adapter)

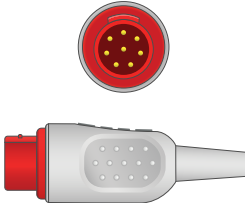
Models	Adapter	Options	Part Number	OEM #
Mennen Envoy and Vitalogik 5500		For Argon Transducers	IC-MN-AGO	
		For B. Braun Transducers	IC-MN-BBO	
		For BD Transducers	IC-MN-BDO	684248
		For Edwards Transducers	IC-MN-EDO	
		For Medex Abbott Transducers	IC-MN-MX0	
		For Utah Transducers	IC-MN-UTO	
		For Medex Logical Transducers	IC-MN-MX10	

Mindray IBP Adapter (Also see 6-Pin IBP Adapter)

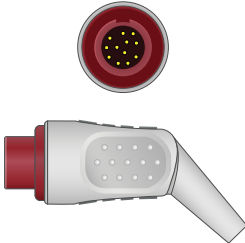
Models	Adapter	Options	Part Number	OEM #
Beneview T5, T6, T8, DPM6, DPM7		For Argon Transducers	IC-MR-AGO	
		For B. Braun Transducers	IC-MR-BBO	
		For BD Transducers	IC-MR-BDO	001C-30-70757
		For Edwards Transducers	IC-MR-EDO	0010-21-12179
		For Medex Abbott Transducers	IC-MR-MX0	
		For Utah Transducers	IC-MR-UTO	650-206
		For Medex Logical Transducers	IC-MR-MX10	

Nihon Kohden IBP Adapter

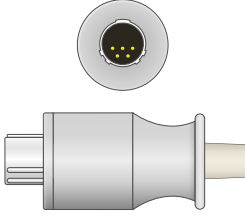
Models	Adapter	Options	Part Number	OEM #
Life Scope BSM: 1100 series, 1200 series, 1230A, 2100 series, 2300* series, 3100 series, 4100* series, 5100* series, 7100 series, 7200 series, 8300 series, 8500 series, 8800 series, 9500* series. Life Scope BSS 9800* series. Life Scope 8, 9, 11, 12, 14. Life Scope OEC 6000 and 7000 series. Life Scope OMP. *Requires adapter cable JP-910P from Nihon Kohden		For Argon Transducers	IC-NK1-AG0	
		For B. Braun Transducers	IC-NK1-BB0	
		For BD Transducers	IC-NK1-BD0	684090
		For Edwards Transducers	IC-NK1-ED0	
		For Medex Abbott Transducers	IC-NK1-MX0	
		For Utah Transducers	IC-NK1-UT0	650-225
		For Medex Logical Transducers	IC-NK1-MX10	
Life Scope TR, BSM-6000 series, BSM-6301K, BSM-6501K, BSM-6701K, BSM-9101K, Life Scope J		For Argon Transducers	IC-NK2-AG0	
		For B. Braun Transducers	IC-NK2-BB0	
		For BD Transducers	IC-NK2-BD0	JP-900P
		For Edwards Transducers	IC-NK2-ED0	JP-902P
		For Medex Abbott Transducers	IC-NK2-MX0	
		For Utah Transducers	IC-NK2-UT0	
		For Medex Logical Transducers	IC-NK2-MX10	

Pace Tech *(See 6-Pin IBP Adapter)*

Philips IBP Adapter

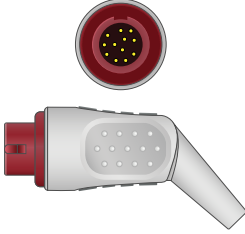
Models	Adapter	Options	Part Number	OEM #
78341A, 78342A, 78352A, M1165A, 78354C, 78205A-D, Merlin, Viridia 24, CMS 24, V26, M2, M3, M4, M1006A/B, M1026A, M1166A, M1175A, M1350B, M1205A, M1350A, M1353A, 8030A, 8040A, 3536A, all HP Monitors Model # XX, MXXXXA M1006A - BPM Module, M1006B, Merlin 1300, Omnicare M1006A to M1176A		For Argon Transducers	IC-HP-AG0	
		For B. Braun Transducers	IC-HP-BB0	M1634A
		For BD Transducers	IC-HP-BD0	684081
		For Edwards Transducers	IC-HP-ED0	
		For Medex Abbott Transducers	IC-HP-MX0	
		For Utah Transducers	IC-HP-UT0	650-206
		For Medex Logical Transducers	IC-HP-MX10	

Physio Control *(See 6-Pin IBP Adapter)*

Siemens *(See Drager)*

Spacelabs IBP Adapter *(Also see 6-Pin IBP Adapter)*

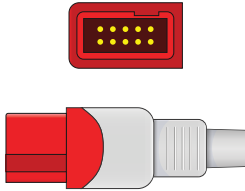
Models	Adapter	Options	Part Number	OEM #
Ultraview		For Argon Transducers	IC-SL-AG0	
		For B. Braun Transducers	IC-SL-BB0	
		For BD Transducers	IC-SL-BD0	
		For Edwards Transducers	IC-SL-ED0	
		For Medex Abbott Transducers	IC-SL-MX0	
		For Utah Transducers	IC-SL-UT0	
		For Medex Logical Transducers	IC-SL-MX10	

Welch Allyn *(See 6-Pin IBP Adapter)*

Zoll *(See 6-Pin IBP Adapter)*

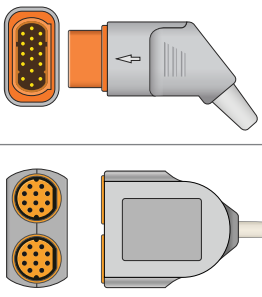
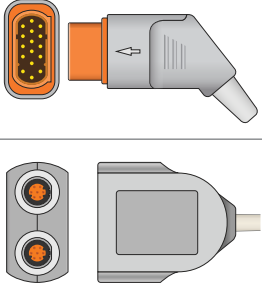
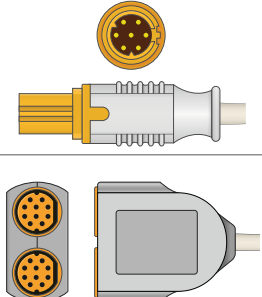
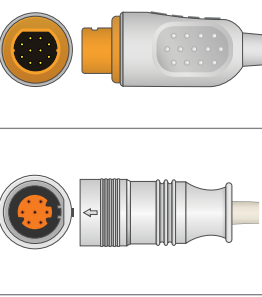
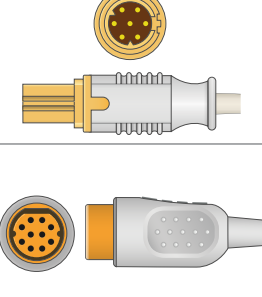

Dräger IBP Converter

Specification	Converter	Options	Part Number	OEM #
IBP converter cable used for converting a Spacelabs IBP connector to two Siemens 10-Pin adapter cables. 1 foot cable.		IBP Converter Cable	IC-S-SM1/20	5731281
IBP converter cable used for converting a Spacelabs IBP connector to two Siemens 6-Pin adapter cables. 1 foot cable.		IBP Converter Cable	IC-S-SM2/20	5592147
IBP converter cable used for converting a Spacelabs IBP connector to two Siemens 10-Pin adapter cables. 1 foot cable.		IBP Converter Cable	IC-SM2-SM1/20	
IBP converter cable used for converting a Spacelabs IBP connector to a Siemens 6-Pin adapter cable. 1 foot cable.		IBP Converter Cable	IC-SM1-SM20	
IBP converter cable used for converting a Spacelabs IBP connector to a Siemens 10-Pin adapter cable. 1 foot cable.		IBP Converter Cable	IC-SM2-SM10	

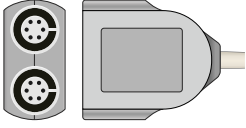
Marquette (GE) IBP Converter

Specification	Converter	Options	Part Number	OEM #
Compatible IBP converter cable used for converting a Marquette IBP connector to a standard 6-Pin adapter cable. 1 foot cable.	 	IBP Converter Cable	IC-MQ-AD/20	700-0028-00

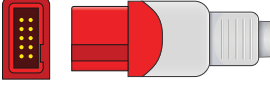
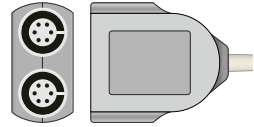

Spacelabs IBP Converter

Specification	Converter	Options	Part Number	OEM #
IBP converter cable used for converting a Spacelabs IBP connector to one standard 6-Pin adapter cable. 1 foot cable.	 	IBP Converter Cable	IC-SL-AD0	
IBP converter cable used for converting a Spacelabs IBP connector to two standard 6-Pin adapter cables. 1 foot cable.	 	IBP Dual Converter Cable	IC-SL-AD/20	700-0028-00

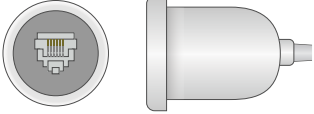
Abbott Medex Disposable IBP Transducer

Photo	Connector	Options	Part Number
		Box of 20 disposable IBP transducers	IP-MX-300

Edwards TruWave Disposable IBP Transducer

Photo	Connector	Options	Part Number
		Box of 20 disposable IBP transducers	IP-ED-300

B. Braun Disposable IBP Transducer

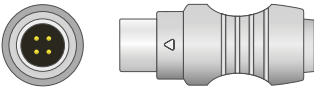
Photo	Connector	Options	Part Number
		Box of 20 disposable IBP transducers	IP-BB-300

Utah Disposable IBP Transducer

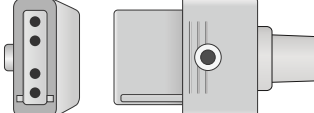
Photo	Connector	Options	Part Number
		Box of 20 disposable IBP transducers	IP-UT-300

Why are we different? Because we're experts in patient monitor accessories. This is all we do and that makes us great. Call us at 866-373-6767 to talk to an expert today.

Pressure Infusion Bags

Photo	Description	Options	Part Number
	<p>Disposable, single-use pressure infusion bags reduce the risk of cross-contamination common with reusable bags. Easy to use, includes hook for hanging fluid bag, bulb to inflate bags and pressure relief valve which protects the bag from over-inflation (320mmHg pressure relief). Bag is transparent to easily view the IV bag and its fluid level. Easy bag loading and unloading, color coding allows for identification, patient customization box provides area to write patient and drug information. 0-300mmHg gauge is color coded and allows for one-hand inflation. Latex free. Available in 500mL and 1,000mL options.</p>	500mL	DPI-500
		1000mL	DPI-1000

Semi-Reusable Pressure Infusion Bags

Photo	Description	Options	Part Number
	<p>Semi-reusable pressure infusion bags are more durable than disposable bags but less expensive than reusable bags. Encourages frequent disposal of bags without the expense of fully-disposable pressure infusion bags; these bags can be reused if desired. Easy to use, easy to clean, includes hook for hanging fluid bag, bulb to inflate bags and pressure relief valve which protects the bag from over-inflation (320mmHg pressure relief). Easy bag loading and unloading, color coding allows for identification, patient customization box provides area to write patient and drug information. 0-300mmHg gauge is color coded and allows for one-hand inflation. Latex free. Available in 500mL and 1,000mL options in dark grey.</p>	500mL	HPI-500
		1000mL	HPI-1000

Reusable Pressure Infusion Bags

Photo	Description	Options	Part Number
	<p>Durable, reusable pressure infusion bags are easy to use, easy to clean, includes hook for hanging fluid bag, bulb to inflate bags and pressure relief valve which protects the bag from over-inflation (320mmHg pressure relief). These reusable bags are more durable than disposable infusion bags and have the benefit of a built-in bladder. The parts can be replaced as the design includes threaded connectors to easily remove and change parts. Easy bag loading and unloading, color coding allows for identification, patient customization box provides area to write patient and drug information. 0-300mmHg gauge is color coded and allows for one-hand, precise inflation. Latex free. Available in 500mL and 1,000mL options in dark blue.</p>	500mL	PI-500
		1000mL	PI-1000



Temperature

Compatible, reusable temperature probes

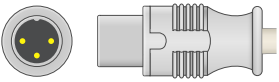

Air Shields Reusable Temperature Probes

Models	Connector	Options	Part Number	OEM #
		Adult Skin Sensor	DAS-15AS0	
		Adult Rectal Sensor	DAS-15AG0	

Artema S&W Reusable Temperature Probes

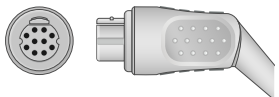
Models	Connector	Options	Part Number	OEM #
		Adult Skin Sensor	DSW-AS0	
		Adult Rectal Sensor	DSW-AG0	

Atom Reusable Temperature Probes

Models	Connector	Options	Part Number	OEM #
Atom Medical Infant Warmer V-3200D, V-505, Infant Incubator V-2100G, V-2200, Transport Incubator V-707, V-808		Pediatric Skin Sensor	DAT-15PS0	
		Pediatric Rectal Sensor	DAT-15PG0	

CAS Med (See YSI)

Criticare (See YSI)



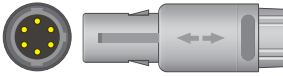

Critikon Reusable Temperature Probes

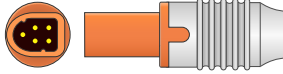
Models	Connector	Options	Part Number	OEM #
Critikon Dinamap XL and 9300 Series monitors		Oral Probe	DOP-GE0010	8978
		Rectal Probe	DRP-GE-0010	8976

Datascope Reusable Temperature Probes (Also see YSI)

Models	Connector	Options	Part Number	OEM #
Datascope Passport V		Adult Skin Sensor	DDT-AS0	040-000057-00
		Adult Rectal Sensor	DDT-AG0	040-000055-00

Datascope Temperature Adapters

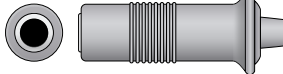

Models	Connector	Options	Part Number	OEM #
For use with disposable temperature probes	<p>To Monitor:</p>  <p>To Philips Mono Probe:</p>  <p>To GE Dual Pin Probe:</p> 	Philips Mono Probe	DDT-30-PHO	040-000091-00
		GE Dual Pin Probe	DDT-30-ADO	
For use with reusable YSI 400 temperature probes	<p>To Monitor:</p>  <p>To YSI 400 Probe:</p> 	1 Foot Cable	DDT-ADO	

Datex Ohmeda (See YSI)

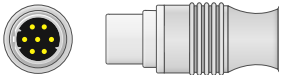
Drager Reusable Temperature Probes (Also see YSI)

Models	Connector	Options	Part Number	OEM #
Siemens Drager Infinity Vista, Delta, Gamma, Kappa		Adult Skin Sensor	DSM-ASO	5204669
		Adult Rectal Sensor	DSM-AGO	5204644, 5204651

Drager Temperature Adapters

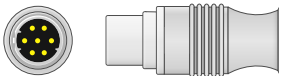
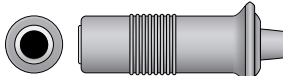
Models	Connector	Options	Part Number	OEM #
For use with disposable temperature probes	<p>To Monitor:</p>  <p>To Philips Mono Probe:</p>  <p>To GE Dual Pin Probe:</p> 	Philips Mono Probe	DSM-30-PHO	11-CA-407-04, 11-CA-407-12
		GE Dual Pin Probe	DSM-30-ADO	
For use with reusable YSI 400 temperature probes	<p>To Monitor:</p>  <p>To YSI 400 Probe:</p> 	1 Foot Cable	DSM-ADO	5198333

Infinium (See YSI)

Invivo (See YSI)

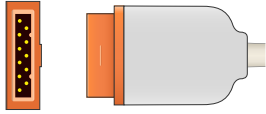

Marquette (GE) Reusable Temperature Probes

Models	Connector	Options	Part Number	OEM #
Carescape, Dash, Eagle, Tram, Solar, Mac-Lab, Cath-Lab		Adult Skin Sensor	DMQ-AS0	
		Adult Rectal Sensor	DMQ-AG0	
		Adult Skin Double Sensor	DMQ2-AS0	

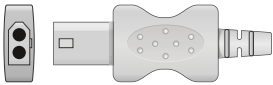
Marquette (GE) Disposable Temperature Probes

Models	Connector	Options	Part Number	OEM #
For use with temperature adapter cables		Adult/Pediatric Skin, Case of 20	DMQ-D-N0	8001642
		Adult/Pediatric Esophageal/Rectal, Case of 20	DMQ-DAG-N0	8001643, 8001644, V3417, ER400-9

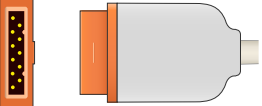

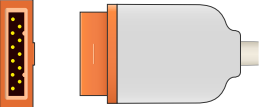
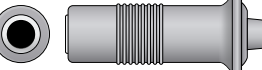
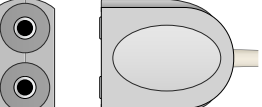

Marquette (GE) Temperature Adapters

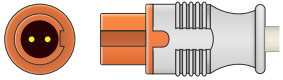
Models	Connector	Options	Part Number	OEM #
For use with disposable temperature probes	<p>To Monitor:</p>  <p>To Philips Mono Probe:</p>  <p>To GE Dual Pin Probe:</p> 	Philips Mono Probe	DMQ-30-PH0	2021700-001
		GE Dual Pin Probe	DMQ-30-AD0	2021701-001
For use with reusable YSI 400 temperature probes. 1 foot cable	<p>To Monitor:</p>  <p>To YSI 400 Probe:</p>  <p>To DUAL 400 Probe:</p> 	Single Temp	DMQ-AD0	2021700-001
		Dual Temp YSI 400	DMQ400-AD20	2016998-001
		Dual Temp YSI 700	DMQ700-AD20	402015-004

Mindray Reusable Temperature Probes (Also see YSI)

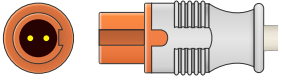
Models	Connector	Options	Part Number	OEM #
Mindray T5, T8 and iPM-9800		Adult Skin Sensor	DMR-AS0	0011-30-37393
		Adult Rectal Sensor	DMR-AGO	0011-30-37382

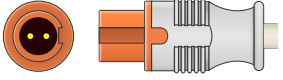
Mindray Temperature Adapters

Models	Connector	Options	Part Number	OEM #
For use with disposable temperature probes	<p>To Monitor:</p>  <p>To Philips Mono Probe:</p>  <p>To GE Dual Pin Probe:</p> 	Philips Mono Probe	DMR-30-PHO	011-30-37391, 0011-30-90444
		GE Dual Pin Probe	DMR-30-ADO	
For use with reusable YSI 400 temperature probes	<p>To Monitor:</p>  <p>To YSI 400 Probe:</p> 	1 Foot Cable	DMR-ADO	

Nihon Kohden (See YSI)





Philips Reusable Temperature Probes

Models	Connector	Options	Part Number	OEM #
For use with M1029A temperature module		Adult Skin Sensor	DHP-AS0	21078A
		Adult Rectal Sensor	DHP-AGO	21075A

Philips Disposable Temperature Probes

Models	Connector	Options	Part Number	OEM #
For use with temperature adapter cables		Adult/Pediatric Skin, Case of 20	DHP-D-N0	21091A, 989803100951
		Adult/Pediatric Esophageal/Rectal, Case of 20	DHP-DAG-N0	21090A, 989803100941, M1837A, 989803105321



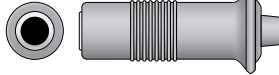

Philips Temperature Adapters

Models	Connector	Options	Part Number	OEM #
For use with disposable temperature probes	<p>To Monitor:</p>  <p>To Philips Mono Probe:</p>  <p>To GE Dual Pin Probe:</p> 	Philips Mono Probe	DHP-30-PHO	21082A, 21082B, 98980310921
		GE Dual Pin Probe	DHP-30-ADO	
For use with reusable YSI 400 temperature probes	<p>To Monitor:</p>  <p>To YSI 400 Probe:</p> 	1 Foot Cable	DHP-ADO	

Spacelabs Reusable Temperature Probes

Models	Connector	Options	Part Number	OEM #
All Spacelabs monitors including Ultraview		Adult Skin Sensor	DSL-AS0	20700-4000-00
		Adult Rectal Sensor	DSL-AG0	
		Adult Skin Double Sensor	DSL2-AS0	

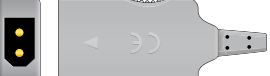
Spacelabs Temperature Adapters

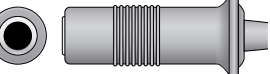

Models	Connector	Options	Part Number	OEM #
For use with disposable temperature probes	<p>To Monitor:</p>  <p>To Philips Mono Probe:</p>  <p>To GE Dual Pin Probe:</p> 	Philips Mono Probe	DSL-30-PHO	
		GE Dual Pin Probe	DSL-30-ADO	
For use with reusable YSI 400 temperature probes. 1 foot cable	<p>To Monitor:</p>  <p>To YSI 400 Probe:</p> 	Single Temperature	DSL-AD0	
		Dual Temperature	DSL-AD20	700-4000-00

Welch Allyn (See YSI)

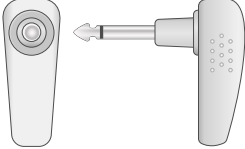
YSI Reusable Temperature Probes

Models	Connector	Options	Part Number	OEM #
CASMed: 750; Criticare: 506, 507, 507E, 507ELC, 507S, 508, 1100, 2200, 8100 series; Datascope: Passport 2, Spectrum, Spectrum OR, Passport XG, Trio; Datex Ohmeda: S/3, CS/3, S/5, Cardiacap 1, Cardiacap 2, Cardiacap 5, Light Monitor, Satellite Plus; Dräger: Delta, Vista, Gamma, Kappa; Invivo: MDE Prism; Mindray: PM 7000, PM 8000, PM 9000 Express, PM 9000, VS-800; Nihon Kohden: BSM-2300 Life Scope I, BSM-4100 Life Scope P, BSM-5100 Life Scope A, BSM-9510 Life Scope M, BSM-9800 Life Scope S.; Welch Allyn: Atlas		Adult Skin Sensor	D2252-AS0	409B, 401, 709B, 701, 01-02-0326, YSI-409A, 422, 5201335, M35373, M1024254, 0206-02-0003
		Adult Rectal Sensor	D2252-AG0	420, 01-02-0327, 01-02-0379, 5201319, YSI-401, M1024247, 0206-02-0001
		Pediatric Skin Sensor	D2252-PS0	
		Pediatric Rectal Sensor	D2252-PG0	

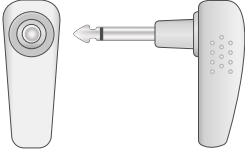
YSI Temperature Adapters

Models	Connector	Options	Part Number	OEM #
All monitors requiring YSI temperature sensors	To Monitor:  To Philips Mono Probe:  To GE Dual Pin Probe: 	Philips Mono Probe	DYSI-30-PH0	989803162591
		GE Dual Pin Probe	DYSI-30-AD0	165641, 0012-00-0975, 700-4000-00, 9445-801



Ultrasound Transducers

Compatible Ultrasound, Toco
Transducers and Repair Cables

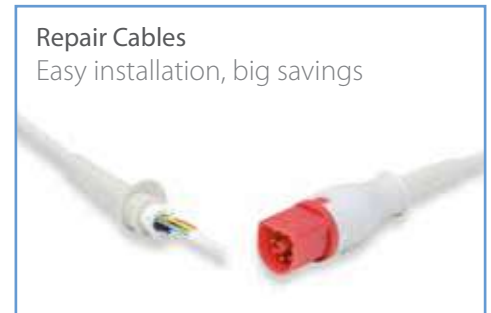

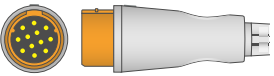
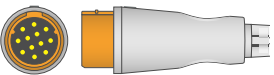
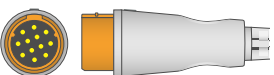

Corometrics Ultrasound Transducer

Models	Connector	Part Number	OEM #
Corometrics Nautilus 5700LAX Corometrics 116, 118, 120, 128, 129, 145, 150, 151, 155, 170, 171, 172, 173, 174, 250, 259 and 340 monitors		UFU300-100	5700LAX
Corometrics Nautilus 5700HAX Corometrics 116, 118, 120, 128, 129, 145, 150, 151, 155, 170, 171, 172, 173, 174, 250, 259 and 340 monitors		UFU300-200	5700HAX
Corometrics Nautilus 5600AAX Corometrics 115 and 145 monitors		80310170	5600AAX

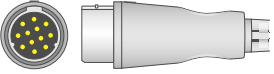
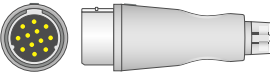

Corometrics Toco Transducer

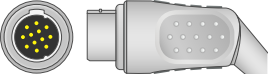
Models	Connector	Part Number	OEM #
Corometrics Nautilus 2264LAX for Corometrics 116, 118, 120, 128, 129, 150, 151, 155, 170, 171, 172, 173, 174, 250, 259 and 340 monitors Corometrics 116, 118, 120, 129, 150, 151, 155, 170, 171, 250 and 340 monitors		UFT300-100	2264LAX
Corometrics Nautilus 2264HAX for Corometrics 116, 118, 120, 128, 129, 150, 151, 155, 170, 171, 172, 173, 174, 250, 259 and 340 monitors		UFT300-200	2264HAX

Corometrics Transducer Repair Cable

Models	Connector	Part Number	OEM #
Use this compatible cable to repair the GE Corometrics 5700AAX ultrasound transducer		X-US-CR20	
Use this compatible cable to repair the GE Corometrics 2264AAX toco transducer		X-TC-CR10	

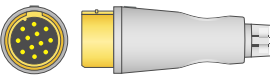
Oxford Huntleigh Ultrasound Transducer

Models	Connector	Part Number	OEM #
Oxford Sonicaid Team Duo 1.5MHz		80310400	8400-6919
Oxford Sonicaid Team Duo 2MHz		80310390	8400-6920

Oxford Huntleigh Toco Transducer

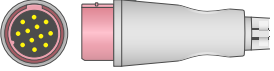
Models	Connector	Part Number	OEM #
Oxford Sonicaid Team Duo		80320260	8400-6921

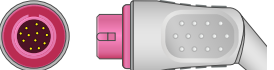
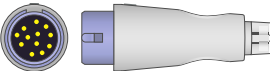

Philips Ultrasound Transducer

Models	Connector	Part Number	OEM #
Model 1350 and Series 50 monitors		UFU200-200	M1356A
HP 8040A and 8041A monitors		UFU200-100	15245A

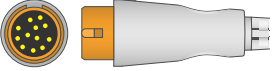
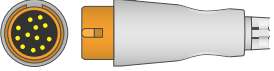
Philips Toco Transducer

Models	Connector	Part Number	OEM #
Model 1350 and Series 50 monitors		UFT200-200	M1355A
HP 8040A and 8041A monitors		80320250	15248A

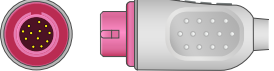
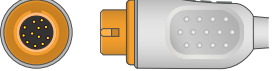
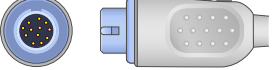
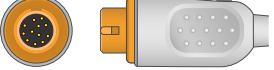
Philips Transducer Repair Cable

Models	Connector	Part Number	OEM #
Use this cable to repair the Philips M1356A ultrasound transducer		X-US-HP10	
Use this cable to repair the Philips M1355A toco transducer		X-TC-HP10	
Use this cable to repair the Philips 15245A ultrasound transducer		X-US-HP20	
Use this cable to repair the Philips 15248A toco transducer		X-TC-HP20	
Use this cable to repair the Philips M2736A/ M2734A ultrasound and toco transducer		X-US/TC-HP30	

Spacelabs Ultrasound Transducer

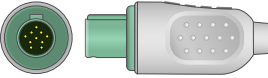
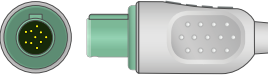
Models	Connector	Part Number	OEM #
Spacelabs US91 for IM76, AM66 and Kontron monitors		UFU500-200	US91, AMS-20-0011
Spacelabs US915 for IM67 and AM77 monitors		80310110	US915, AMS-20-0047

Spacelabs Toco Transducer

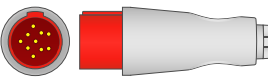
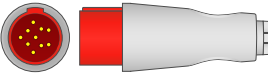
Models	Connector	Variant SKU	OEM #
TD84 for IM76, AM66 and Kontron monitors		80320070	TD84, AMS-20-0020
Spacelabs TD84 for IM77 and AM67 monitors		80320080	TD84, AMS-20-0048



Oxygen Sensors
Accurate, reliable,
12 – 24 month
warranties



O₂ Cells

Compatible O₂ sensors for
respiratory applications

6051-0000-216 O₂ Cell

Models	Warranty	Response Time	Part Number
Compatible Datex Ohmeda 6051-0000-216 O ₂ sensor for use with: City Technologies, Envitec, Nuova, Stephanie, Viamed <ul style="list-style-type: none"> • City Technologies: MOX-10 • Envitec: OOM202-2S • Datex Ohmeda: 6051-0000-216 • Nuova: E-110 • Viamed: R-42V 	16 months	<12s	G0-110

MAX-1 O₂ Cell

Models	Warranty	Response Time	Part Number
Compatible Maxtec MAX-1 O ₂ sensor for use with: Datex Ohmeda Excel 210-7800, Excel 7800, Modulus 4700, Modulus 7800, Oxicap, 510, 051, 205, 125, 5100, 5120, 5125, 5140, 5125, 5200, 5250, 5250 RMG, 5400, 7200, 7800, 7810 Vent, S5172802; Envitec, Drager; Hamilton Medical; Mercury Medical MSA; Pacifitech; Teledyne #C-41131; VTI; Viamed <ul style="list-style-type: none"> • Air Shields: C-100 • Analytical Industries: PSR-11-915 • Biotest: S101 • Ceramtec: CAG-1 • City Technologies: MOX-6 • CR: R-15 • Datex Ohmeda: 0237-2034-700 • Drager: 6803290 • Envitec: OOM101 • Hamilton: HM-10, HM-13 • HP: 15201A • Hudson-RCI: 5556 • Integral Process: 65001 • Maxtec: MAX-1 R113P90 • Mercury Medical: 10-103-17 • MSA: 655264,655263 • Nivaco: R-15 • Nuova: E-15/0 • Pacifitech: PT-10 • Sensidyne: SV-14A • SensorTech: ST-10 • Teledyne: R-15, #C-41131 • Viamed: R-15 • VTI: VT1272, 101272, 100352 	12 months	<17s	G0-010

MAX-10 O₂ Cell

Models	Warranty	Response Time	Part Number
<p>Compatible Maxtec MAX-10 O₂ sensor for use with: Analytical Industries; Envitec; Datex Engstrom Modulus SE7900; Datex Ohmeda Excel 210-7900, Modulus SE1700, Smart Vent, S-5, Aespire, Avance, Airsys, Aestiva 3000; Maxtec; Nuova; Teledyne; Viamed</p> <ul style="list-style-type: none"> Analytical Industries: PSR-11-915-4 Ceramatec: CAG-10 Envitec: OOM110 Datex Ohmeda: 6050-0004-110 Integral Process: 65008 Maxtec: MAX-10 R112P10 Mercury Medical: 10-103-10 Nuova: E-15/4 Pacifitech: PT-20A Sensidyne: SV-20A Teledyne: R-30MED Ventrex: V-20A Viamed: R-30V 	16 months	<12s	G0-100

MAX-11 O₂ Cell

Models	Warranty	Response Time	Part Number
<p>Compatible Maxtec MAX-11 O₂ sensor for use with: Drager Narkomed 1A, 2, 2B, 3, 4, 6000, Babylog 8000, Savina, SA2 Anaesthesia Mach, Evita, Evita 2, Evita 4, Evita 2 Dura, Fabius, Fabius GS, Oxydig, Oxycom 100 D, PM8030, I-8000, Incubator 8000IC, Anemone; Datex Ohmeda; Envitec; Hamilton; Maxtec; Teledyne #C-61339, Viamed R-23V</p> <ul style="list-style-type: none"> Analytical: PSR-11-915-2 Drager: 6850645,6803290 Envitec: OOM201 Datex Ohmeda: 6051-000-224 Hamilton: HM-14, HM-13 Hudson-RCI: 5557, V-14 Maxtec: MAX-11 R113P10 MSA: 655263, 655264 Nuova: E-15/2 Teledyne: R-23MED 	12 months	<12s	G0-020

MAX-11i O₂ Cell

Models	Warranty	Response Time	Part Number
<p>Compatible Maxtec MAX-11i O₂ sensor for use with: Drager, Envitec, Maxtec, Nuova</p> <ul style="list-style-type: none"> Drager: I-8000 Envitec: OOM104 Maxtec: MAX-11i R113P06 Nuova: E-8000 	16 months	<12s	G0-080

MAX-12 O₂ Cell

Models	Warranty	Response Time	Part Number
<p>Compatible Maxtec MAX-12 O₂ sensor for use with: Analytical Industries; Bird Avea Ventilator; Citi Technologies; Envitec; EME Hamilton Medical Viasys Arabella, Galileo, Raphael, Aladdin, 51254; Emerson Infant Flow; Datex Ohmeda; Hamilton Instruments Galileo, Raphael, Arabella, Multinex, Analyser; Infrasonics Adult Star 601T; Maxtec; MSA; Nuova; Puritan Bennett NP 840 Ventilator 4-074925-00; Siemens Servo 900C, 900D, 900E, Servo 300, 300A, SV 300, Servo 700, 710, SV900, V710, C/D, 9000, Infinity Delta; Spacelabs Capnograph; Taema Cesar 2, Horus; Teledyne TED 160, TED 190; and Viamed</p> <ul style="list-style-type: none"> Analytical Industries: PSR-11-917-J Ceramatec: CAG-12 City Technologies: MOX-9, R-24 Envitec: OOM202 Datex Ohmeda: 6051-0000-222 Hamilton Medical: 396008, 396009, HM-12 Hudson RCI: 5566, V-12 Integral Process: 65016 IMT Medical: PF300 Maxtec: MAX-12 R109P45 Mercury Medical: 10-103-06 MSA: 472062,470644 Nuova: E-17/M Pacifitech: PT-12A Siemens: 9004979-E347E, 6419332-E380E Sensidyne: SV-12A SensorTech: ST-01 Spacelabs: 90513 Taema: YR049700 Teledyne: R24 MED, B-62321 Ventrex: V-12A Viamed: R-24Med VTI Vascular Technology: 103100 	16 months	<12s	G0-040

MAX-12A O₂ Cell

Models	Warranty	Response Time	Part Number
<p>Compatible Maxtec MAX-12A O₂ sensor for use with: Air Shields Isolette; Analytical Instruments; City Technologies; Criticare 8100 Poet, 8500 Poet; Envitec; Datex Ohmeda Centiva S/5; Hamilton Galileo, Raphael, Arabella, Multinex Analys; Hudson RCI; Maxtec; Nuova; Taema Cesar (new); Teledyne; Viamed</p> <ul style="list-style-type: none"> Analytical Industries: PSR-11-917 Biotest: A 103 City Technologies: MOX-1 Criticare: 644 Datex Engstrom: 0600-00-0002 Envitec: OOM102 GE Marquette: R-22 Hamilton Cells: HM-12 Henleys: 5556 Hill-Rom: R-22 Hudson RCI: 5566, V-12 Infrasonics: R-22 Maxtec: MAX-12A R109P48 Mercury Medical: 10-103-15 Narco Med: R-22 Nuova: E-17/A2 Pacifitech: PT-12AIR SensorTech: ST-12 Spacelabs: 90514 Teledyne: R-22MED Viamed: R-22Med 	16 months	<12s	G0-120

MAX-12C O₂ Cell

Models	Warranty	Response Time	Part Number
Original Maxtec MAX-12C O ₂ sensor for use with Viasys Avea Ventilator, Infant SiPaP • Maxtec: MAX-12C, R109P53	24 months	<6s	MAX-12C

MAX-13 O₂ Cell

Models	Warranty	Response Time	Part Number
Compatible Maxtec MAX-13 O ₂ sensor for use with: Bird Products 6400, 8400, VIP Vent, Sentry; Envitec; Datex Engstrom Elvira, Erica; Datex Ohmeda; Hamilton; Hudson; Maxtec; MSA Mini-Ox I-III; Nuova; Puritan Bennett PB 850, 7820 Monitor, 7200 Ventilator; Respironics Esprit Ventilator Lifecare; Taema Eole, Cesar; Teledyne; Viamed • Air Shields: 6735142 • Alphamed: R-17 • Analytical Instruments: PSR-11-917-J • BCI: R-17 • BioMed Devices: M-2, M-10 • Biotest: C102-1 • Bird Products: 66030 • BMD: 10006 • Ceramtec: CAG-13 • Citi Technologies: MOX-2 • Dameca: 42035-46 • Envitec: OOM103-1, OOM202-1 • Datex Ohmeda: 6051-0000-217 • Hamilton: HM-11 • Henleys: 5567 • Hudson-RCI: 5567, V-11 • Invivo: 9445 • Integral Process: 65005 • Kontron: ABT 5100 • Lifecare: PLV-100, 37-079 • Maxtec: MAX-13 R115P10 • Mercury Medical: 10-103-05 • MSA: 406931 • Nuova: E-17/J • Oxitron: 3310 • Pacifitech: PT-11A • Puritan Bennett: 4-020933-00 • Respironics: 37-079 • Sensidyne: SV-11A • SensorTech: ST-11 • Ventrex: V-14A • Viamed: R-41V • VTI: 100580	16 months	<12s	G0-030

MAX-13C O₂ Cell

Models	Warranty	Response Time	Part Number
Compatible Maxtec MAX-13C O ₂ sensor for use with: Maxtec, Nuova <ul style="list-style-type: none"> • Maxtec: MAX-13C • Nuova: E-14/0 	16 months	<12s	G0-140

MAX-14 O₂ Cell

Models	Warranty	Response Time	Part Number
Compatible Maxtec MAX-14 O ₂ sensor for use with: Envitec, Maxtec, MSA Min-Ox IA, Nuova <ul style="list-style-type: none"> • Ceramatec: CAG-14 • Devilbiss: O2ANA-101 • Envitec: OOM202-2 • Maxtec: MAX-14 R116P80 • Mercury Medical: 10-103-13 • MSA: 806572 • Nuova: E-8000 • Pacifitech: PT-23 • Sensidyne: SV-26 • Ventrex: V-26 	16 months	<12s	G0-090

MAX-16 O₂ Cell

Models	Warranty	Response Time	Part Number
Compatible Maxtec MAX-16 O ₂ sensor for use with: Maxtec, Nuova and Covidien Puritan Bennett models 740, 760, 840; Versamed iVent 201 <ul style="list-style-type: none"> - Maxtec: MAX-16 R114P70 - Mercury Medical: 10-103-14 - Nuova: E-16/0 - Puritan Bennett: 4-072214-00 	16 months	<12s	G0-160

MAX-17 O₂ Cell

Models	Warranty	Response Time	Part Number
Compatible Maxtec MAX-17 O ₂ sensor for use with: Analytical Industries; City Technologies; Envitec; Datex Ohmeda; Hamilton; Hudson RCI; Maxtec; MSA; Nuova; Sechrist Industries 650 Ventilator 43170; Teledyne TED 60J, TED 60T, TED 191T, TED 200T, TED 200T7; Viamed <ul style="list-style-type: none"> • Analytical Industries: PSR-11-77 • Ceramatec: CAG-17 • City Technologies: MOX-4 • Envitec: OOM105 • Datex Ohmeda: 6051-0000-219 • Hamilton: HM-03 • Hudson RCI: 5558, V-03 • Integral Process: 65013 • Maxtec: MAX-17 R116P10 • Mercury Medical: 10-103-02 • MSA: 804674 • Newport: OM 100, VM 200 • Nuova: E-77/0 • Sensidyne: SV-03 • SensorTech: ST-03 • Teledyne: T-7 • Ventrex: V-03 • Viamed: T-7 	16 months	<8s	G0-070

MAX-18 O₂ Cell

Models	Warranty	Response Time	Part Number
<p>Compatible Maxtec MAX-18 O₂ sensor for use with: Analytical Industries, Envitec, Hudson RCI 5525, 5528, 5529, 5550, 5552; Maxtec, MSA, Nuova, Teledyne, Viamed</p> <ul style="list-style-type: none"> • Analytical Industries: PSR-11-33-1, PSR-11-33-2 • Ceramatec: CAG-18 • Envitec: OOM107-2 • Hudson RCI: 5569, V-02 • Integral Process: 65000 • Maxtec: MAX-18 R116P40 • Megamed: M1 • Mercury Medical: 10-103-01 • MSA: 485905, 655262 • Nuova: E-33/1 • Oxytron: 3050 • Pacifitech: PT-02 • Sensidyne: SV-02 • SensorTech: ST-02 • Teledyne: C1R, C2R • Ventrex: V-02 • Ventronics: 5525, 5528, 5529 • Viamed: C-2R 	12 Months	<20s	G0-060

MAX-19 O₂ Cell

Models	Warranty	Response Time	Part Number
<p>Compatible Maxtec MAX-19 O₂ sensor for use with: Analytical Industries; Deversified Diagnostics Xenematic; Envitec; Hamilton Veolar, Amadeus, Aladdin; Heyer Pocket O₂; Hudson RCI 5525, 5528, 5529, 5550, 5552; Maxtec; MSA; Nuova; Taema KV050501, Oxy 2100; Teledyne TED 160, TED 190; Viamed</p> <ul style="list-style-type: none"> • Analytical Industries: PSR-11-33 • Bertucci: T1, T2 • BioMed Devices: 48351 • Bio Tek: X74223 • Ceramatec: CAG-19 • Emerson: EMV-OA • Envitec: OOM107 • Fresenius: X74223 • Hamilton: HM-01 • Henleys: 5569 • Hudson RCI: 5568, C1, V-01 • Imed: 810, 825 • Inmed: T-1, T-2 • Integral Process: 65007 • Ivac: 1200, 1225 • Libra: OM500 • Maxtec: MAX-19 R116P60 • Medigas: T-1, T-2 • Megamed: M2 • Mercury Medical: 10-103-00 • MSA: 478841, 485955 • Nuova: E-33/0 • Oxitron: 3250 • Pacifitech: PT-01 • Sensidyne: SV-01 • SensorTech: ST-01 • Taema: KV050501 • Teledyne: T1, T2 • Toptronics: XT74223 • Ventrex: V-01 • Viamed: T-1, T-2 • Vickers: 251 	12 Months	<20s	G0-050

MAX-2 O₂ Cell

Models	Warranty	Response Time	Part Number
<p>Original Maxtec MAX-2 O₂ sensor for use with Analytical Industries; Drager Narkomed Series, Fabius GS, Fabius, GS, Tiro, 6850645, 6803290; Philips HP; Invivo: Magnitude; Mercury Medical; Pacifitech; Teledyne; VTI.</p> <ul style="list-style-type: none"> Analytical Industries: PSR-11-915-1 Drager: 6850645, 6803290 HP: 15201A Maxtec: MAX-2, R107P20 Mercury Medical: 10-103-12 Pacifitech: PT-24 Teledyne: R31 VTI: 101372 	24 months	<15s	MAX-2

MAX-250 O₂ Cell

Models	Warranty	Response Time	Part Number
<p>Original Maxtec MAX-250 O₂ sensor for use with Maxtec OM-25A; Mercury Medical; Pacifitech; Teledyne</p> <ul style="list-style-type: none"> Maxtec: MAX-250, R125P01-002 Mercury Medical: 10-103-11 Pacifitech: PT-250 Teledyne: R29 	24 months	<15s	MAX-250

MAX-250E O₂ Cell

Models	Warranty	Response Time	Part Number
<p>Original Maxtec MAX-250E O₂ sensor for use with Maxtec MaxO2+AE, OM-25AE, OM-25ME, MaxBlend, MaxVenturi; Analytical Industries; CareFusion Cardinal, Viasys; Sentry Blender; Fluke VT Mobile; Mercury Medical; Newport Medical e360 and e500 vents; Pacifitech; Teledyne; Viasys Sentry Blender, 66045</p> <ul style="list-style-type: none"> Analytical Industries: PSR-11-917-J1 Maxtec: MAX-250E, R125P03-002 Mercury Medical: 10-103-08 Pacifitech: PT-25A Teledyne: R29MED/#C-70592 Viasys: 66045 	24 months	<15s	MAX-250E

MAX-250ESF O₂ Cell

Models	Warranty	Response Time	Part Number
<p>Compatible Maxtec MAX-250ESF O₂ sensor for use with: Analytical Industries, Maxtec, Nuova</p> <ul style="list-style-type: none"> Analytical Industries: PSR-11-917-J1 Maxtec: MAX-250ESF R115P85 Mercury Medical: 10-103-08 Nuova: E-25/0 Pacifitech: PT-25A Sensidyne: SV-25A 	16 months	<12s	G0-250

MAX-3 O₂ Cell

Models	Warranty	Response Time	Part Number
Compatible Maxtec MAX-3 O ₂ sensor for use with: City Technologies; Maxtec; Nuova and Penlon Prisma SP2 <ul style="list-style-type: none"> • City Technologies: MOX-3 • Maxtec: MAX-3 R109P11 • Nuova: E-77/05 	12 months	<15s	G0-0750

MAX-43 O₂ Cell

Models	Warranty	Response Time	Part Number
Compatible Maxtec MAX-43 O ₂ sensor for use with: Datex Ohmeda Giraffe, Maxtec, Nuova <ul style="list-style-type: none"> • Maxtec: MAX-43 R109P07 • Mercury Medical: 10-103-16 • Nuova: E-43/0 • GE: 6600-1278-600 	12 months	<17s	G0-430

MAX-47 O₂ Cell

Models	Warranty	Response Time	Part Number
Compatible Maxtec MAX-47 O ₂ sensor for use with: Maxtec, Nuova; Hudson 5801 <ul style="list-style-type: none"> • Hudson RCI: 5803 • Maxtec: MAX-47 • Mercury Medical: 10-103-20 • Nuova: E-47/0 	12 months	<12s	G0-470

MAX-48 O₂ Cell

Models	Warranty	Response Time	Part Number
Compatible Maxtec MAX-48 O ₂ sensor for use with: Analytical Industries, Maxtec, Nuova <ul style="list-style-type: none"> • Analytical Industries: M-11-60 • Maxtec: MAX-48 • Nuova: E-60 	12 months	<12s	G0-480

MAX-7 O₂ Cell

Models	Warranty	Response Time	Part Number
Compatible Maxtec MAX-7 O ₂ sensor for use with: Analytical Industries; City Technologies; Envitec OxiQuant M; Maxtec; MSA Mini-OX3000; Nuova; Siare Morpheus; Taema Alys, Clarys, YR010100; Stephan Artec; Teledyne TED AX 300; Viamed <ul style="list-style-type: none"> • Analytical Industries: PSR-11-917J • Atom: OX-60 • City Technologies: MOX-2 • Datascope: 0600-00-0106 • Envitec: OOM102-1 • Maxtec: MAX-7 • Mercury Medical: 10-103-18 • Nuova: E-15/5 • Pacifitech: PT-11A • Spacelabs: 015-0285-00 • Teledyne Cells: C43690 R-17MED • Viamed: R-26Med 	16 months	<12s	G0-150

MAX-8 O₂ Cell

Models	Warranty	Response Time	Part Number
Original Maxtec MAX-28 O ₂ sensor for use with Analytical Industries; GE (Datex Ohmeda) Excel Modulus, 5250 (ext. only), 5100, 5150, 5120/5125; Mercury Medical; Teledyne; VTI <ul style="list-style-type: none"> • Analytical Industries: PSR-11-915-3 • GE Datex Ohmeda: 0237-2034-700 • Maxtec: MAX-8, R107P22 • Mercury Medical: 10-103-13 • Teledyne: R32MED, #B-73463 • VTI: 101272 	24 months	<15s	MAX-8

MAX-9 O₂ Cell

Models	Warranty	Response Time	Part Number
Compatible Maxtec MAX-9 O ₂ sensor for use with: Analytical Instruments; Hudson RCI 6477, 5577, 5584, 5590, 5595; Maxtec; MSA; Nuova; Teledyne #B 39636; Viamed <ul style="list-style-type: none"> • Air Shields: 6736140 • Analytical Industries: PSR-11-55 • Ceramatec: CAG-9 • Hudson RCI: 5500, V-05 • Integral Process: 65003 • Maxtec: MAX-9 R114R80 • Mercury Medical: 10-103-03 • MSA: 655265 • Nuova: E-55/0 • Oxitron: 3110 • Pacifitech: PT-05 • SensorTech: ST-05 • Teledyne: R-13 • Ventronics: 5500, 5570, 5575, 5584, 5590, 5595 • Viamed: R-13 	12 months	<15s	G0-130

809-531-2628

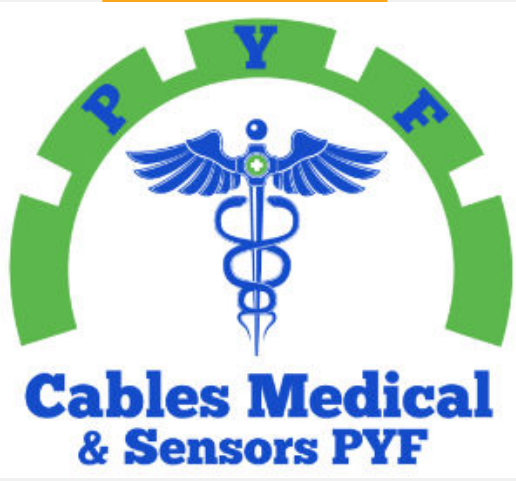

SAME-DAY Shipping! Order by 5PM EST
www.cablesmedical.com

